



HIRSCHMANN

A **BELDEN** BRAND

User Manual

Installation

Modular Industrial Ethernet Backbone Switch

MACH4002 family

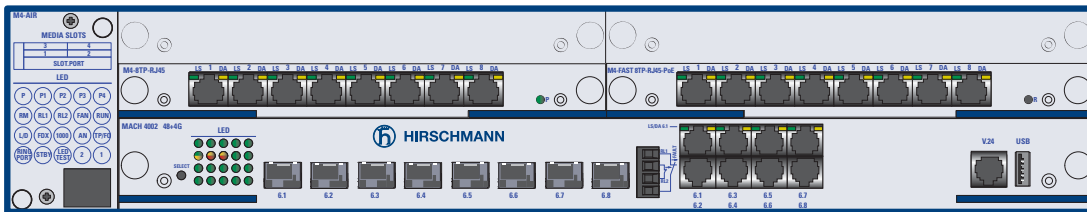

MACH4002-24G

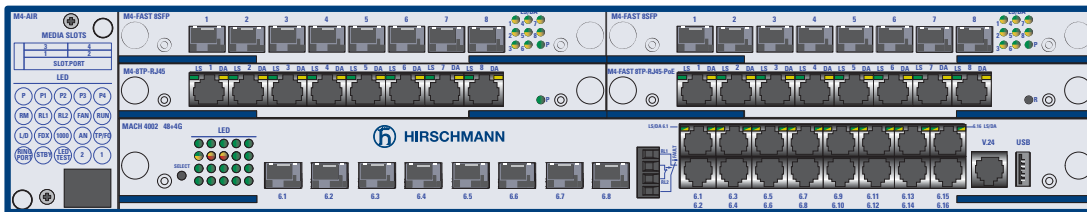

MACH4002-48G

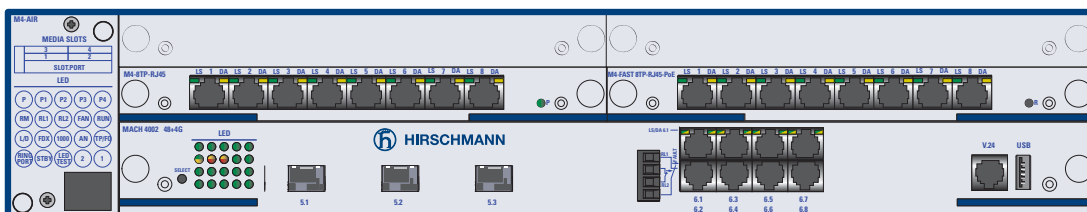

MACH4002-24G+3X

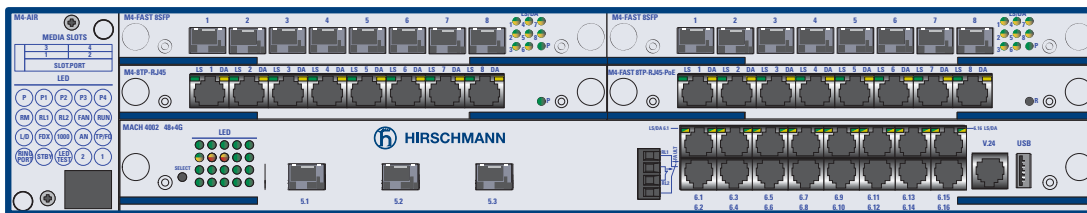

MACH4002-48G+3X

The naming of copyrighted trademarks in this manual, even when not specially indicated, should not be taken to mean that these names may be considered as free in the sense of the trademark and tradename protection law and hence that they may be freely used by anyone.

© 2021 Hirschmann Automation and Control GmbH

Manuals and software are protected by copyright. All rights reserved. The copying, reproduction, translation, conversion into any electronic medium or machine scannable form is not permitted, either in whole or in part. An exception is the preparation of a backup copy of the software for your own use.

The performance features described here are binding only if they have been expressly agreed when the contract was made. This document was produced by Hirschmann Automation and Control GmbH according to the best of the company's knowledge. Hirschmann reserves the right to change the contents of this document without prior notice. Hirschmann can give no guarantee in respect of the correctness or accuracy of the information in this document.

Hirschmann can accept no responsibility for damages, resulting from the use of the network components or the associated operating software. In addition, we refer to the conditions of use specified in the license contract.

You can get the latest version of this manual on the Internet at the Hirschmann product site (www.hirschmann.com).

Hirschmann Automation and Control GmbH
Stuttgarter Str. 45-51
72654 Neckartenzlingen
Germany

Contents

Important Information	6
Safety instructions	7
About this manual	13
Key	14
1 Description	15
1.1 General device description	15
1.2 MACH4002 Basic Device	16
1.3 Supply voltage	20
1.3.1 Power supply connections on the rear side of the device	21
1.3.2 M4-POWER power unit chassis	21
1.4 Fan	23
1.4.1 M4-AIR plug-in fan	23
1.4.2 Monitoring temperature and fan	24
1.5 Integrated basic board	25
1.5.1 Left area of basic board	26
1.5.2 Right area of basic board	27
1.6 Signal contact	28
1.7 Media modules	28
1.7.1 M4-8TP-RJ45	29
1.7.2 M4-FAST 8-SFP	29
1.7.3 M4-GIGA 8-SFP	29
1.8 SFP/XFP transceiver	30
1.9 Ethernet ports	31
1.9.1 10/100/1000 Mbit/s twisted pair port	31
1.9.2 100 Mbit/s F/O port	31
1.9.3 1000 Mbit/s F/O port	32
1.9.4 10-Gbit/s F/O port	32
1.9.5 Combo ports	32
1.10 Display elements	33
1.10.1 Device state	33

1.10.2	Port status display	35
1.10.3	ACA Auto Configuration Adapter	36
2	Installation	39
2.1	Checking the package contents	39
2.2	Installing the device and grounding	39
2.2.1	Selecting the assembly location	39
2.2.2	Mounting on a flat surface	40
2.2.3	Mounting in a switch cabinet	40
2.2.4	Grounding the device	42
2.3	Mounting the power supply unit on the back of the MACH4002 device	42
2.4	Mounting the power unit chassis, connecting with the MACH4002 device	43
2.5	Installing the M4-AIR... plug-in fan unit	44
2.6	Installing the plug-in power units in the M4-POWER power unit chassis	45
2.7	Installing media modules	45
2.8	Installing an SFP transceiver (optional)	47
2.9	Connecting the supply voltage	47
2.10	Wiring and installing the signal contact	49
2.11	Connecting data cables	50
3	Making basic settings	51
4	Maintenance and service	52
5	Deinstallation	53
5.1	Removing a media module	53
5.2	Removing an SFP transceiver (optional)	54
5.3	Deinstalling the M4-AIR... plug-in fan unit	54
6	Technical data	55
6.1	General technical data	55
6.2	Dimension drawings	56
6.3	Interfaces	57

6.4	EMC and immunity	57
6.5	Network range	58
6.5.1	10/100/1000 Mbit/s twisted pair port	58
6.5.2	Fast Ethernet SFP transceiver	58
6.5.3	Bidirectional Fast Ethernet SFP transceiver	59
6.5.4	Gigabit Ethernet SFP transceiver	60
6.5.5	Bidirectional Gigabit Ethernet SFP transceiver	61
6.6	Power consumption/power output	63
6.7	Scope of delivery	64
6.7.1	MACH4002-...	64
6.7.2	M4-POWER	64
6.7.3	M4-S-...	64
6.7.4	M4-P-...	64
6.8	Order numbers/product description	65
6.9	Accessories	66
6.10	Underlying technical standards	69
A	Further support	70

Important Information

Notice: Read these instructions carefully, and look at the equipment to become familiar with the device before trying to install, operate, or maintain it. The following special messages may appear throughout this documentation or on the equipment. The message warns of potential hazards or calls attention to information that clarifies or simplifies a procedure.

■ Symbol explanation



This is the safety alert symbol. It is used to alert you to potential personal injury hazards. Obey all safety messages that follow this symbol to avoid possible injury or death.



The addition of this symbol to a “Danger” or “Warning” safety label indicates that an electrical hazard exists, which will result in personal injury if the instructions are not followed.



This symbol points out the dangers posed by hot device surfaces. In connection with safety notes, the disregard of these instructions will result in injury.

WARNING

WARNING indicates a potentially hazardous situation which, if not avoided, **can result in** death or serious injury.

CAUTION

CAUTION indicates a potentially hazardous situation which, if not avoided, **can result in** minor or moderate injury.

NOTICE

NOTICE is used to address practices not related to physical injury.

Safety instructions

■ General safety instructions

You operate this device with electricity. Improper usage of the device entails the risk of physical injury or significant property damage. The proper and safe operation of this device depends on proper handling during transportation, proper storage and installation, and careful operation and maintenance procedures.

- Before connecting any cable, read this document, and the safety instructions and warnings.
- Operate the device with undamaged components exclusively.
- The device is free of any service components. In case of a damaged or malfunctioning device, turn off the supply voltage and return the device to Hirschmann for inspection.

■ Qualification requirements for personnel

- Only allow qualified personnel to work on the device.

Qualified personnel have the following characteristics:

- ▶ Qualified personnel are properly trained. Training as well as practical knowledge and experience make up their qualifications. This is the prerequisite for grounding and labeling circuits, devices, and systems in accordance with current standards in safety technology.
- ▶ Qualified personnel are aware of the dangers that exist in their work.
- ▶ Qualified personnel are familiar with appropriate measures against these hazards in order to reduce the risk for themselves and others.
- ▶ Qualified personnel receive training on a regular basis.

■ Certified usage

Use the device solely for the application cases described in the Hirschmann product information, including this manual.

Operate the device solely according to the technical specifications.

■ National and international safety regulations

Verify that the electrical installation meets local or nationally applicable safety regulations.

■ Supply voltage

Every time you connect the electrical conductors, make sure that the following requirements are met:

- ▶ Devices with DC power supply are designed for the operation with Safety Extra Low Voltage. On the DC supply voltage connections, exclusively connect PELV or SELV circuits according to IEC 60950-1 or ES1 circuits according to IEC/EN 62368-1.
- ▶ The supply voltage complies with the description on the type plate of your device.

- ▶ The complete defective plug-in power supply unit must be changed.
- ▶ For safety reasons, the fuse installed in the plug-in power supply units may not be changed.
- ▶ Only switch on the device when the housing is closed. Close all empty slots with a covering panel.
- ▶ Screw the power supply units to the housing before connecting the input voltage.
- ▶ If you are using the M4-POWER power unit chassis: Check the configuration of the connection plugs and the power supply cable to the switch chassis before you connect an external voltage to the M4-POWER inputs.
- ▶ Only use connection cables that are permitted for a temperature range from 0 °C ... +60 °C (+32 °F ... +140 °F).
- ▶ Only use copper wire/conductors of class 1, +75 °C (+167 °F).
- ▶ Only use the M4-POWER CABLE for the redundant power supply.
- ▶ Only use the M4-POWER power supply unit for the redundant power supply. Do not connect any other external voltage source.
- ▶ Use undamaged parts.

■ **Safe grounding**

Make sure you ground the devices assembled in the switch cabinet safely. In particular, check the supply voltage connections if they are not connected directly to the supply cable (e.g. when using power strips).

■ **Signal contacts (“FAULT”)**

Exclusively connect SELV circuits with voltage restrictions according to IEC 60950-1 or ES1 circuits according to IEC/EN 62368-1 to the signal contacts.

■ **Shielded ground**

The shielded ground wire of the twisted pairs cables is connected to the front panel as a conductor.

Beware of possible short circuits when connecting a cable section with conductive shield braiding.

■ **ESD Guidelines**

Media modules are equipped with electrostatically sensitive components. These can be destroyed by the effect of an electric field or by charge equalization when touching the printed circuit board or the contacts, or their lifetime can be affected. Media modules are therefore delivered packed in a conductive ESD protection bag. The packaging is reusable. Make sure you adhere to the following protection measures for electrostatically endangered assemblies:

- Create electrical equipotential bonding between yourself and your environment, e.g. using a wristband, which you clamp to the basic device (knurled screw of an interface card). When the power supply

cable is connected, the basic device is grounded via the power supply connection.

- Only now do you take the card out of the conductive bag.
- Outside the basic device, only store the cards in a conductive ESD protective bag.

ESD protective field equipment is available for the safe handling of electrostatically endangered assemblies.

Further information about electrostatic sensitive modules can be found in DIN EN 61340-5-1 (2007-08) and DIN EN 61340-5-2 (2007-08).

■ **Device casing**

Only technicians authorized by the manufacturer are permitted to open the casing.

The device is grounded via the voltage supply socket.

- ▶ Reduced air flow: Install the device in the switch cabinet in such a way that ensures sufficient air flow for operating the device safely.
- ▶ Keep the ventilation slits free to ensure good air circulation.
- ▶ Make sure there is at least 3.94 in (10 cm) of space in front of the ventilation slits of the casing.
- ▶ Never operate the device without a plug-in fan.
[See “Fan” on page 23.](#)
- ▶ Never insert pointed objects (narrow screwdrivers, wires, etc.) into the device or into the connection terminals for electric conductors. Do not touch the connection terminals.
- ▶ Seal all unused slots with cover panels.
- ▶ Modules, fans and power supply units of a switched-on device may only be installed or removed by an electrician.
- ▶ Fans are subject to natural wear. If one or more fans in the plug-in fan fail, function and lifetime of a device can be negatively affected or the device may fail completely. Use the monitoring functions of the device for fans and temperature.

Depending on your installation conditions, it may be possible to continue operating your device after one fan has failed. Observe the temperature display of your device.

- In the Command Line Interface with the command: show temperature.
- In the Graphical User Interface, in the dialog Basic settings: System, Temperature

The displayed temperature must not exceed the maximum value of +80 °C (+176 °F).

- ▶ The basic board must not be removed.
Removing the basic board invalidates the guarantee.
- ▶ The chassis should be installed in the horizontal position.
- ▶ After the device is switched off, the fan blades continue rotating for a number of seconds. Do not reach into a rotating fan!

- ▶ The internal workings of the basic device are not for users! Do not reach inside a switched-on device because of the danger caused by high energy densities.
- ▶ When fully equipped with media modules, the device weighs up to 10 kg. Please comply with the legally stipulated maximum weight when dealing with heavy objects.
- ▶ If you are operating the device in a 19" switch cabinet: install sliding/mounting rails for supporting the weight of the device.
See "Mounting in a switch cabinet" on page 40.

■ Installation site requirements

Operate the device at the specified ambient temperature (temperature of the ambient air at a distance of 2 in (5 cm) from the device) and at the specified relative humidity exclusively.

- ▶ When you are selecting the installation location, make sure you observe the climatic threshold values specified in the technical data.
- ▶ Use the device in an environment with a maximum pollution degree that complies with the specifications in the technical data.
- ▶ Increased ambient temperature: When you are operating the device in a closed switch cabinet or together with other devices in a switch cabinet, the ambient temperature in the switch cabinet can be higher than the ambient temperature in the room. Only install the device in an ambient temperature in line with the maximum ambient temperature specified by the manufacturer: t_{\max} .
- ▶ Mechanical stress: Install the device in a switch cabinet in such a way that rules out hazardous conditions due to severe mechanical stress.

■ Strain relief

Note: If the strain relief is insufficient, there is a risk of torsion, contact problems and creeping interruptions.

- Relieve the connection points of cables and lines from mechanical stress.
- Design strain relieves in such a way that they prevent any mechanical damage to cables, wires or conductors caused by external influences or their own weight.
- To prevent damage to device connections, connectors and cables, follow the instructions for proper installation in accordance with DIN VDE 0100-520:2013-06, sections 522.6, 522.7 and 522.13.

■ CE marking

The devices comply with the regulations contained in the following European directives:

2011/65/EU and 2015/863/EU (RoHS)

Directive of the European Parliament and of the Council on the restriction of the use of certain hazardous substances in electrical and electronic equipment.

2014/35/EU

Directive of the European Parliament and of the Council on the harmonisation of the laws of the Member States relating to the making available on the market of electrical equipment designed for use within certain voltage limits.

2014/30/EU (EMC)

Directive of the European Parliament and of the Council on the harmonisation of the laws of the Member States relating to electromagnetic compatibility.

In accordance with the above-named EU directive(s), the EU conformity declaration will be at the disposal of the relevant authorities at the following address:

Hirschmann Automation and Control GmbH
Stuttgarter Str. 45-51
72654 Neckartenzlingen

You find the EU conformity declaration as PDF file for downloading on the Internet at: <https://www.doc.hirschmann.com/certificates.html>

The product can be used in the industrial sector.

- ▶ Interference immunity: EN 61000-6-2
- ▶ Emitted interference: EN 55032
- ▶ Safety: EN 62368-1

You find more information on technical standards here:

[“Underlying technical standards” on page 69](#)

Warning! This is a class A device. This device can cause interference in living areas, and in this case the operator may be required to take appropriate measures.

Note: The assembly guidelines provided in these instructions must be strictly adhered to in order to observe the EMC threshold values.

■ **LED or laser components**

LED or LASER components according to IEC 60825-1 (2014):
CLASS 1 LASER PRODUCT
CLASS 1 LED PRODUCT

■ **FCC note**

Supplier's Declaration of Conformity 47 CFR § 2.1077 Compliance Information

MACH4002

U.S. Contact Information

Belden – St. Louis
1 N. Brentwood Blvd. 15th Floor
St. Louis, Missouri 63105, United States
Phone: 314.854.8000

This device complies with part 15 of the FCC Rules. Operation is subject to the following two conditions: (1) This device may not cause harmful interference, and (2) this device must accept any interference received, including interference that may cause undesired operation.

Note: This equipment has been tested and found to comply with the limits for a Class A digital device, pursuant to part 15 of the FCC Rules. These limits are designed to provide reasonable protection against harmful interference when the equipment is operated in a commercial environment. This equipment generates, uses, and can radiate radio frequency energy and, if not installed and used in accordance with the instruction manual, may cause harmful interference to radio communications. Operation of this equipment in a residential area is likely to cause harmful interference in which case the user will be required to correct the interference at his own expense.

■ **Recycling note**

After usage, this device must be disposed of properly as electronic waste, in accordance with the current disposal regulations of your county, state, and country.

About this manual

The “Installation” user manual contains a device description, safety instructions, a description of the display, and the other information that you need to install the device.

The following manuals are available as PDF files for download on the Internet at <https://www.doc.hirschmann.com/> :

- ▶ User Manual Installation
- ▶ User Manual Basic Configuration
- ▶ User Manual Redundancy Configuration
- ▶ Reference Manual Graphical User Interface
- ▶ Reference Manual Command Line Interface

The Network Management Software Industrial HiVision provides you with options for smooth configuration and monitoring. You find further information on the Hirschmann product pages on the internet: www.hirschmann.com/de/Hirschmann/Industrial_Ethernet/Netzmanagement/index.phtml

With the Industrial HiVision Network Management software, you increase your network security in industrial application areas:

- ▶ Ethernet Early Warning System
- ▶ Easy monitoring of industrial networks
- ▶ Fast display
- ▶ Interface with diagnostic and configuration programs
- ▶ Low deployment cost

Key

The symbols used in this manual have the following meanings:

▶	Listing
□	Work step
■	Subheading

1 Description

1.1 General device description

The modular, industry-compatible MACH4002 Gigabit Ethernet system is used as an industrial backbone system, and also in applications with high data volumes, such as Voice/Video over IP.

The MACH4002 is a modular, industry-compatible Gigabit Ethernet system in a 19" chassis that is also suitable for use as an industrial backbone system.

The MACH4002 devices are designed for the special requirements of industrial automation. They meet the relevant technical standards, provide very high operational reliability, even under extreme conditions, and also long-term reliability and flexibility. The power is supplied by an AC or DC power unit at the back of the device, or it is supplied redundantly via a power unit chassis with up to three hot-swappable plug-in power units. The switches and the power unit chassis are suitable for mounting in the 19" rack.

The device allows you to set up switched Industrial Ethernet networks according to standard IEEE 802.3.

The HIPER-Ring redundancy concept enables you to quickly carry out a reconfiguration, and also a simple configuration with only one additional connection.

The diagnosis LEDs for displaying the operating parameters provide a quick overview.

There are convenient options for managing the device. Manage your devices via:

- ▶ Web browser
- ▶ SSH
- ▶ Telnet
- ▶ HiDiscovery (software for putting the device into operation)
- ▶ Network management software (for example Industrial HiVision)
- ▶ V.24 interface (locally on the device)

The device provides you with a large range of functions, which the manuals for the operating software inform you about. You can download these manuals as PDF files from the Internet on the Hirschmann product pages (<http://www.doc.hirschmann.com>).

1.2 MACH4002 Basic Device

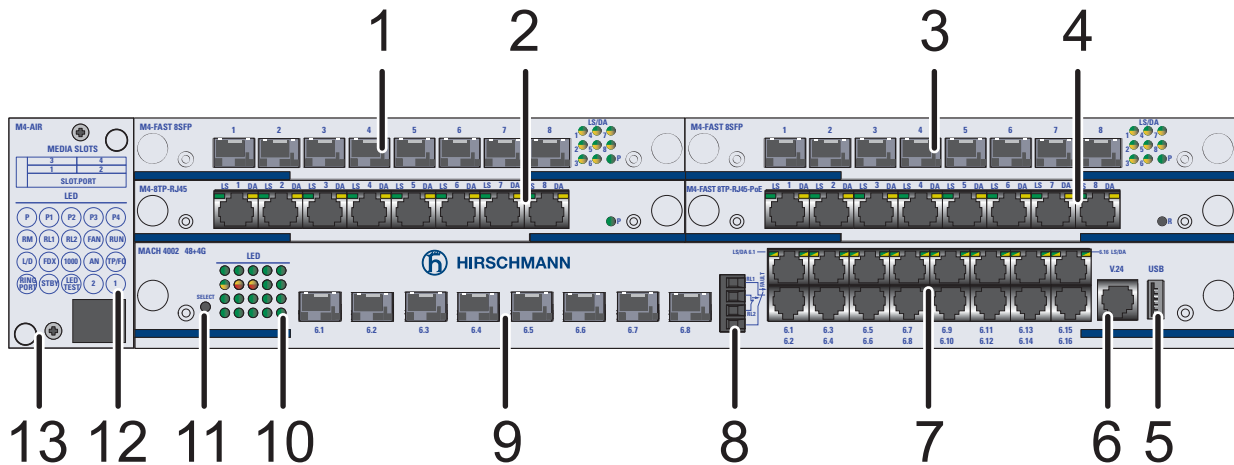

- | | |
|----|--|
| 1 | Media module 3 (plug-in unit) |
| 2 | Media module 1 (plug-in unit) |
| 3 | Media module 4 (plug-in unit) |
| 4 | Media module 2 (plug-in unit) |
| 5 | USB interface |
| 6 | V.24 interface for external management |
| 7 | Basic board (integrated)
16 × Twisted Pair port (Port 6.1 ... 6.16) |
| 8 | 2 × switchable signal contact |
| 9 | Basic board (integrated)
4 × Combo port 5.1 ... 5.4 |
| 10 | LED display elements |
| 11 | SELECT button |
| 12 | Label for the LED display elements |
| 13 | Plug-in fan |

Rear side of the device:

Power supply unit

External connection to M4-POWER

Table 1: Structure of the basic device (Example: MACH4002-48G)

Depending on the MACH4002 device variant, the device provides you with the following ports and slots for equipping it with media modules:

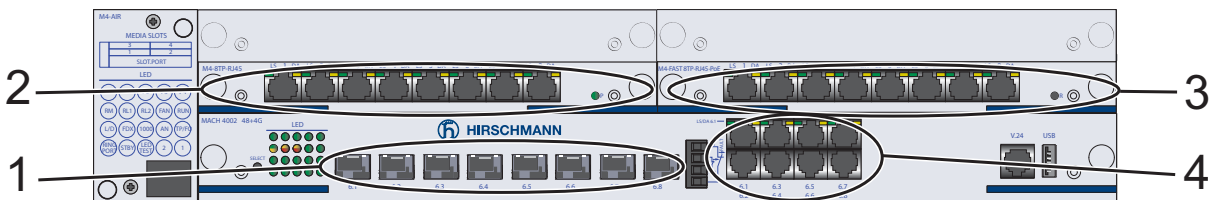

- | | |
|---|---|
| 1 | Basic board (integrated), Port 6.1 ... 6.8, SFP 100/1000 Mbit/s (alternative to the RJ45 Ports 6.1 ... 6.8) |
|---|---|

Table 2: Ports and Media module slots on the MACH4002-24G

2	Media module 1 (plug-in unit), Port 1.1 ... 1.8, 10/100/1000 Mbit/s
3	Media module 2 (plug-in unit), Port 2.1 ... 2.8, 10/100/1000 Mbit/s
4	Basic board (integrated), Port 6.1 ... 6.8, RJ45 10/100/1000 Mbit/s

Table 2: Ports and Media module slots on the MACH4002-24G

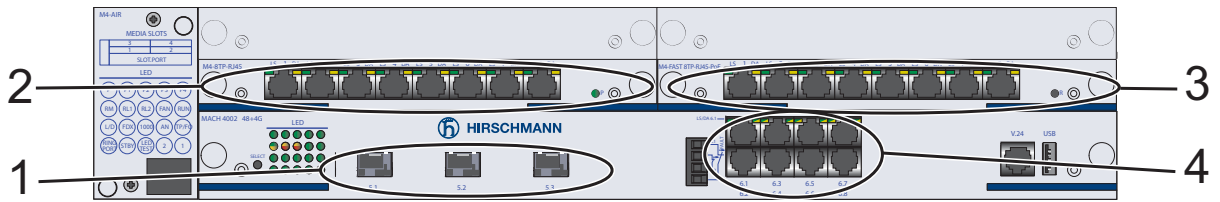

1	Basic board (integrated), Port 5.1 ... 5.3, XFP 10 Gbit/s
2	Media module 1 (plug-in unit), Port 1.1 ... 1.8, 10/100/1000 Mbit/s
3	Media module 2 (plug-in unit), Port 2.1 ... 2.8, 10/100/1000 Mbit/s
4	Basic board (integrated), Port 6.1 ... 6.8, RJ45 10/100/1000 Mbit/s

Table 3: Ports and Media module slots on the MACH4002-24G+3X

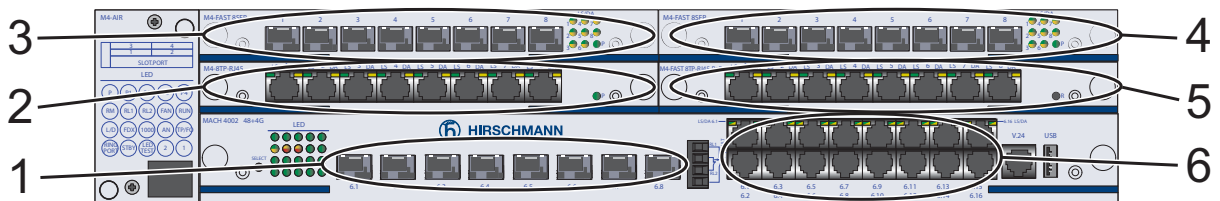

1	Basic board (integrated), Port 6.1 ... 6.8, SFP 100/1000 Mbit/s (alternative to the RJ45 Ports 6.1 ... 6.8)
2	Media module 1 (plug-in unit), Port 1.1 ... 1.8, 10/100/1000 Mbit/s
3	Media module 3 (plug-in unit), Port 3.1 ... 3.8, 10/100/1000 Mbit/s
4	Media module 4 (plug-in unit), Port 4.1 ... 4.8, 10/100/1000 Mbit/s
5	Media module 2 (plug-in unit), Port 2.1 ... 2.8, 10/100/1000 Mbit/s
6	Basic board (integrated), Port 6.1 ... 6.16, RJ45 10/100/1000 Mbit/s

Table 4: Ports and Media module slots on the MACH4002-48G

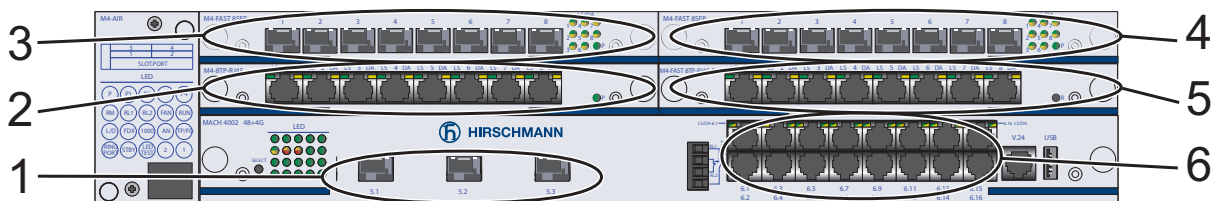

1	Basic board (integrated), Port 5.1 ... 5.3, XFP 10 Gbit/s
2	Media module 1 (plug-in unit), Port 1.1 ... 1.8, 10/100/1000 Mbit/s
3	Media module 3 (plug-in unit), Port 3.1 ... 3.8, 10/100/1000 Mbit/s
4	Media module 4 (plug-in unit), Port 4.1 ... 4.8, 10/100/1000 Mbit/s
5	Media module 2 (plug-in unit), Port 2.1 ... 2.8, 10/100/1000 Mbit/s
6	Basic board (integrated), Port 6.1 ... 6.16, RJ45 10/100/1000 Mbit/s

Table 5: Ports and Media module slots on the MACH4002-48G+3X

Basic device	Maximum number of ports on the device, in brackets number of installed ports on the basic board		Maximum number of media modules			
	TP ports, 10/100 Mbit/s	TP ports, 10/100/1000 Mbit/s	TP/SFP Combo ports, 10/100/1000 Mbit/s	XFP slots, 10 Gbit/s	10/100 Mbit/s	10/100/1000 Mbit/s
4002-24G	- (-)	16 (-)	8 (8 ^a)	- (-)	-	2
4002-48G	- (-)	48 (8)	8 (8 ^c)	- (-)	-	4
4002-24G+3X	- (-)	24 (8)	- (-)	3 (3)	-	2
4002-48G+3X	- (-)	48 (16)	- (-)	3 (3)	-	4

Table 6: Maximum number of ports and media modules

a. SFP 100/1000 Mbit/s

The devices comply with the specifications of the standards:

- ▶ ISO/IEC 8802-3u 100BASE-TX/-1000BASE-TX
- ▶ ISO/IEC 8802-3 100BASE-FX
- ▶ ISO/IEC 8802-3 1000BASE-SX/LX
- ▶ ISO/IEC 8802-3 10GBASE-SR/LR

The MACH4002 basic devices are 2 height modules high (approx. 88 mm) and, depending on the device variant and the connected media, they provide you with

- ▶ up to 48 Fast Ethernet ports
- ▶ up to 48 Gigabit Ethernet ports
- ▶ up to three 10 Gigabit Ethernet ports

See [“Ethernet ports” on page 31](#).

You can order the basic devices with different ranges of functions ([see on page 65 “Order numbers/product description”](#)).

The software supplied defines the range of functions:

- ▶ Software Layer 2 Professional (L2P)
- ▶ Software Layer 3 Enhanced (L3E), static routing
- ▶ Software Layer 3 Professional (L3P), Multicast routing

Depending on the device variant, a basic device has 2 or 4 slots for media modules (media modules 1 ... 2 or 1 ... 4) that are hot-swappable and provide 8 Fast Ethernet/Gigabit Ethernet ports each. The media modules differ with regard to the number of interfaces and the media type for connecting segments.

The integrated basic board is located below the media modules.

The basic board has the following connections:

- ▶ MACH4002-24G: 8 × Gigabit Ethernet ports (SFP-Schächte für 100BASE-FX, 1000BASE-SX/LX, Media module 6, alternative to the RJ45 ports 6.1 ... 6.8) and 8 × Gigabit Ethernet RJ45 ports (10/100/1000BASE-TX, Media module 6).
- ▶ MACH4002-48G: 8 × Gigabit Ethernet ports (SFP-Schächte für 100BASE-FX, 1000BASE-SX/LX, Media module 6, alternative to the RJ45 ports 6.1 ... 6.8) and 16 × Gigabit Ethernet RJ45 ports (10/100/1000BASE-TX, Media module 6).
- ▶ MACH4002-24G+3XP: 3 × 10 Gigabit Ethernet ports (XFP slots for 10GBASE-SR/LR, Media module 5) and 8 × Gigabit Ethernet RJ45 ports (10/100/1000BASE-TX, Media module 6).
- ▶ MACH4002-24G+3XP: 3 × 10 Gigabit Ethernet ports (XFP slots for 10GBASE-SR/LR, Media module 5) and 16 × Gigabit Ethernet RJ45 ports (10/100/1000BASE-TX, Media module 6).

Along with the 10-Gigabit (if present), Gigabit and Fast Ethernet ports, the front of the basic board also has the following connections:

- ▶ A USB socket for connecting an AutoConfiguration Adapter ACA22.
- ▶ A V.24 socket for the network management connection.
- ▶ 2 signal contacts that are integrated on one socket together.

The LED display block on the left side of the basic board informs you about the status of the device. You use the SELECT button to define the meaning of the LED displays.

At the front left of the basic chassis of the MACH4002, there is a replaceable plug-in fan.

On the back of the device there is a slot for a power supply unit:

- ▶ AC plug-in power unit 300 W

The back of the device also has 2 external inputs (voltage input number 3 and 4) for the redundant voltage supply via the M4-POWER power supply unit basic device.

The M4-POWER power unit basic device enables a redundant power supply. Power supply cable(s) between M4-POWER and MACH4002 can be connected at the back of the MACH4002 device. The M4-POWER power supply basic device provides you with 3 slots for plug-in power units:

- ▶ AC plug-in power unit 300 W

1.3 Supply voltage

On the back of the device there is a slot for a power supply unit (AC or DC) and 2 inputs for the redundant power supply via the M4-POWER power supply unit basic device. Both inputs are uncoupled.



Figure 1: Back side of the MACH4002 basic device

1 - M4-POWER connection (voltage input P3-1/P3-2, external)

2 - M4-POWER connection (voltage input P4-1/P4-2, external)

*3 - Slot for slide-in power supply unit
(voltage input P1 and, if required, P2)*

With redundant supply, the power supply unit with the higher output voltage supplies the device on its own. The supply voltage is electrically isolated from the housing.

With non-redundant supply of the mains voltage, the device reports a power failure. You can avoid this message by changing the configuration in the management, or, with power supply units of the same type, by feeding the supply voltage in through both inputs.

1.3.1 Power supply connections on the rear side of the device

■ Power supply plug-in units for switch basic device MACH4002

▶ M4-S-AC/DC 300W

See “Order numbers/product description” on page 65.

Note: The plug-in power units of the M4-POWER power supply basic device cannot be used for the switch basic device.

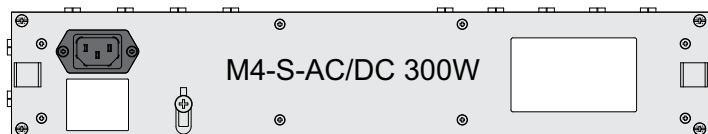

1.3.2 M4-POWER power unit chassis

Note: Consider the sequence for the cabling of the power unit chassis.

See “Mounting the power unit chassis, connecting with the MACH4002 device” on page 43.

The M4-POWER power unit chassis enables redundant power supply. It has three slots for plug-in power units. The plug-in power units can be replaced during operation (hot-swappable).

Depending on the plug-in power units connected, you can use an M4-POWER power unit chassis to implement the redundant power supply for several MACH4002 devices.

- You connect the M4-POWER power units to the M4-POWER connection on the back of the MACH4002 device using the power supply cable supplied with the M4-P-xx plug-in power units.

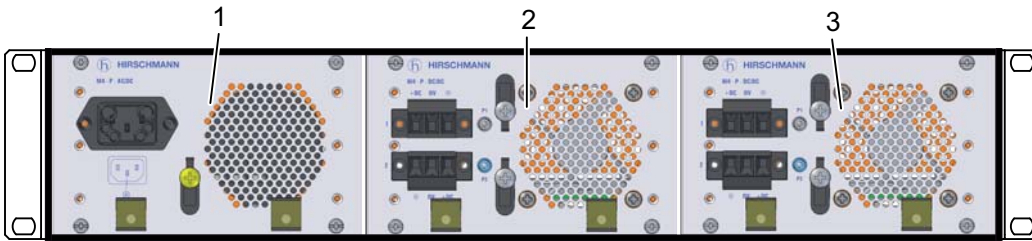

Figure 2: M4-POWER power unit chassis, front side of the device
 (mounting with up to 3 power units)
 1 - Power unit 1
 2 - Power unit 2
 3 - Power unit 3

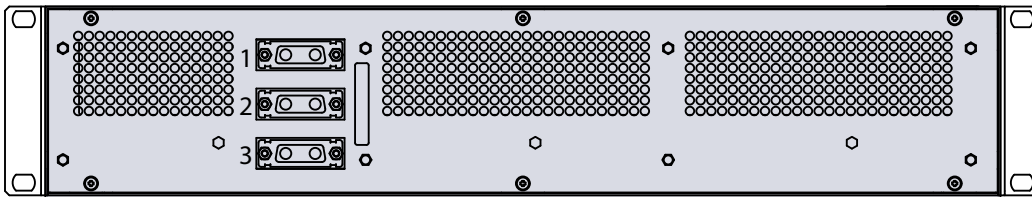

Figure 3: M4-POWER power unit chassis, back side of the device

■ Power supply plug-in units for power supply basic device M4-POWER

▶ M4-P-AC/DC 300W

(see on page 65 “Order numbers/product description”).

Note: The plug-in power units of the M4-POWER power supply basic device cannot be used for the switch basic device.

1.4 Fan

Note: Note the safety instructions in “General safety instructions” on page 7.



1.4.1 M4-AIR plug-in fan

Operate the MACH4002 switch chassis exclusively with plug-in fans as described in the following.

NOTE

OVERHEATING OF THE DEVICE

Depending on the ambient temperature, the device can be operated for a maximum of one to two minutes with the fan unit removed.

Non-adherence to these instructions can lead to material damage.

On the front side of the MACH4002 basic device, the fan plug-in unit M4-AIR is located on the left. You can replace the plug-in fan during operation.

See “Installing the M4-AIR... plug-in fan unit” on page 44.

See “Deinstalling the M4-AIR... plug-in fan unit” on page 54.

▶ **M4-AIR:** Fan plug-in unit for switch basic device MACH4002 without temperature sensor for the use in ambient air temperatures up to maximum +60 °C (+140 °F).

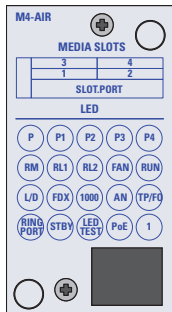
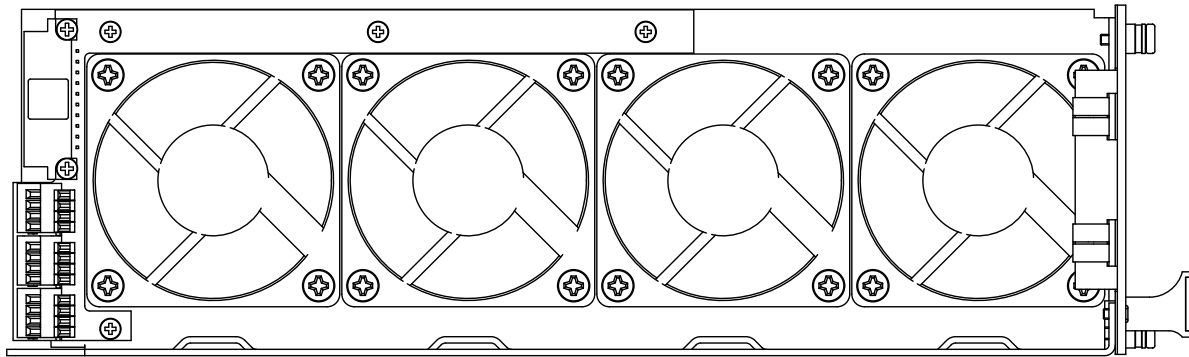

M4-AIR

Figure 4: Fan supply plug-in unit M4-AIR: Side view and front view

1.4.2 Monitoring temperature and fan

■ Fan monitoring

Every individual fan sends a speed-dependent signal to the basic system. The fan monitoring displays the failure of one or more individual fans.

■ The effect of insufficient ventilation

If the device is insufficiently ventilated by its fans, this either causes the assemblies to age faster (MTBF value) or triggers error statuses, and it usually leads to transmission errors on the Ethernet connections.

■ Temperature difference

The difference between the ambient temperature and the circuit board (PCB) temperature is primarily independent of the ambient temperature:

MACH4002 device	Temperature difference Ambient to PCB with all fans at full speed	Temperature difference Ambient to PCB with all fans at half speed
MACH4002-24G/48G	+20 K	+27 K

Table 7: Temperature difference ambient - PCB at full and half fan speed

■ Recommendation for temperature monitoring

Use the following table (based on half speed for all fans) to monitor the temperature of your device. Switch the device off if the temperature values entered in the table are exceeded. This ensures that the device is sufficiently ventilated and is not operated at its limit.

MACH4002 device	Printed circuit board (PCB) temperature threshold value
MACH4002-48+4G	Ambient temperature + 20 K
MACH4002-24G/48G	Ambient temperature + +27 K

Table 8: Temperature monitoring

1.5 Integrated basic board

Depending on the device variant, the integrated basic board provides you with different numbers and types of port.

See “Ethernet ports” on page 31.

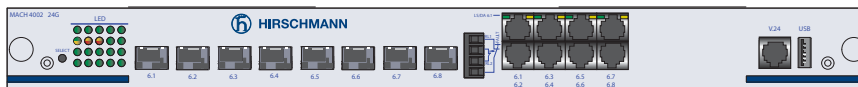

Figure 5: Basic board MACH4002-24G



Figure 6: Basic board MACH4002-48G

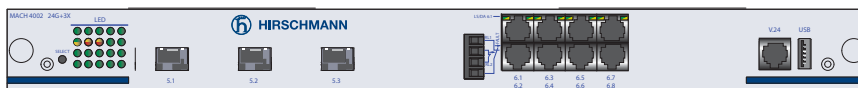

Figure 7: Basic board MACH4002-24G+3X

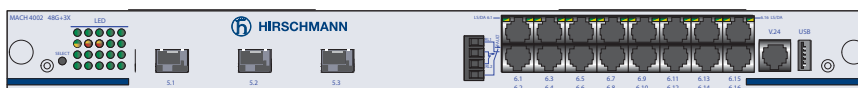
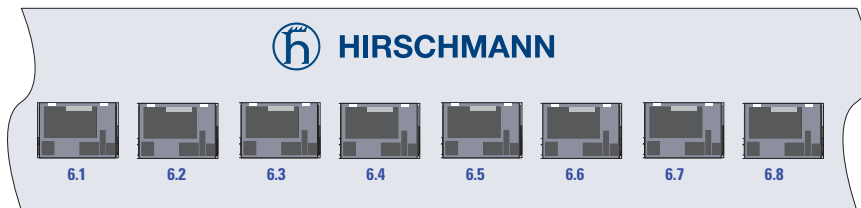

Figure 8: Basic board MACH4002-48G+3X

1.5.1 Left area of basic board

■ Eight Gigabit Ethernet ports (Combo) in MACH4002-24G and MACH4002-48G



There are 8 × Gigabit Ethernet ports (port number 6.1 ... 6.8) for connecting network segments on the left side of the basic board. These are SFP slots that are used as alternatives to RJ45 ports 6.1 ... 6.8. See “Ethernet ports” on page 31.

■ Three 10-Gigabit Ethernet ports (XFP) in MACH4002-24G+3X and MACH4002-48G+3X

There are 3 × 10-Gigabit Ethernet ports (port number 5.1 ... 5.3) for connecting network segments on the left side of the basic board. These ports are XFP slots.

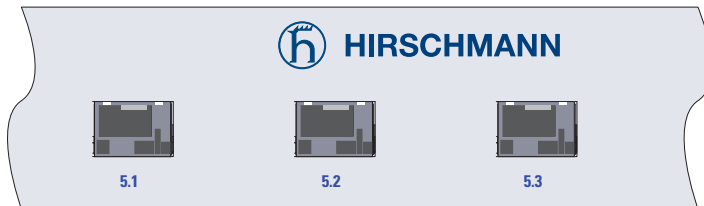

The following 10-Gigabit Ethernet XFP transceivers are available to you for the MACH4002-...-3X:

- M-XFP-SR/LC
- M-XFP-LR/LC
- M-XFP-ER/LC
- M-XFP-ZR/LC

See “Ethernet ports” on page 31.

1.5.2 Right area of basic board

■ 16 Gigabit Ethernet ports in MACH4002-48G and MACH4002-48G+3X

There are 16 × 10/100/1000BASE-TX ports (port number 6.1 ... 6.16) for connecting network segments on the right side of the basic board. These ports are RJ45 sockets.

In the MACH4002-48G, the RJ45 ports 6.1 ... 6.8 can be used as alternatives to the SFP ports 6.1 ... 6.8 on the left side of the basic board (combo ports).

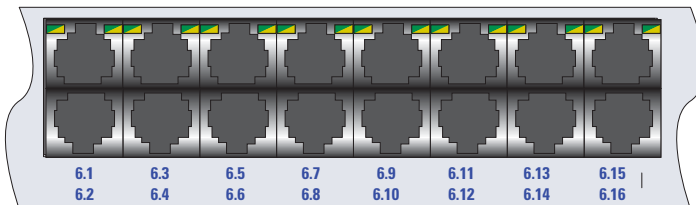

■ 8 Gigabit Ethernet ports in MACH4002-24G and MACH4002-24G+3X

There are 8 × 10/100/1000BASE-TX ports (port number 6.1 ... 6.8) for connecting network segments on the right side of the basic board. These ports are RJ45 sockets.

In the MACH4002-24G, the RJ45 ports 6.1 ... 6.8 can be used as alternatives to the SFP ports 6.1 ... 6.8 on the left side of the basic board (combo ports).

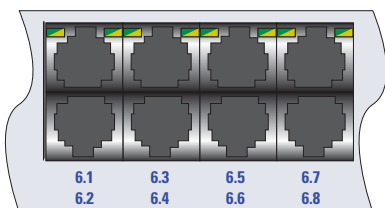

1.6 Signal contact

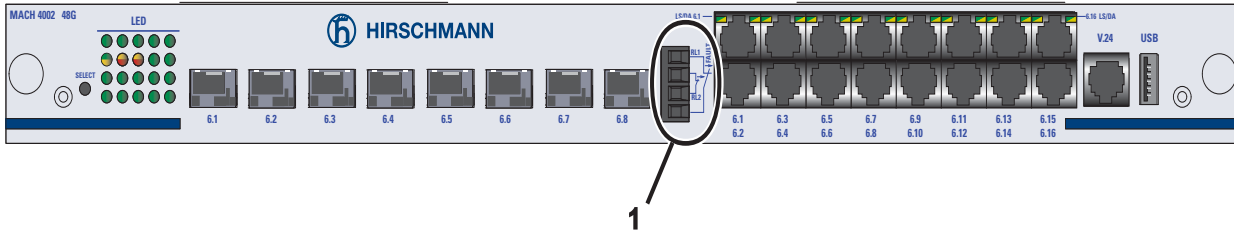

Figure 9: 4-pin signal contact

The signal contact is a potential-free relay contact. The device allows you to perform remote diagnosis via the signal contact. In the process, the device signals events such as a line interruption. When an event occurs, the device opens the relay contact and interrupts the closed circuit. The management setting specifies which events switch a contact. You can also use the management to switch the signal contact manually and thus control external devices.

1.7 Media modules



M4-8TP-RJ45



M4-FAST 8-SFP



M4-GIGA 8-SFP

Figure 10: Fast Ethernet media modules and Gigabit Ethernet media modules

MACH4002 device	M4-8TP-RJ45	M4-FAST 8-SFP	M4-GIGA 8-SFP
MACH4002-24G...	0 ... 2 Media modules	0 ... 2 Media modules	0 ... 2 Media modules
MACH4002-48G...	0 ... 4 Media modules	0 ... 4 Media modules	0 ... 4 Media modules

Table 9: Possible media module configuration of MACH4002 devices

1.7.1 M4-8TP-RJ45

The M4-8TP-RJ45 media module provides you with eight 10/100/1000BASE-TX ports (RJ45 sockets) for connecting network segments.

Note: When used in the MACH4002-48+4G, the media module provides you with eight 10/100BASE-TX ports.

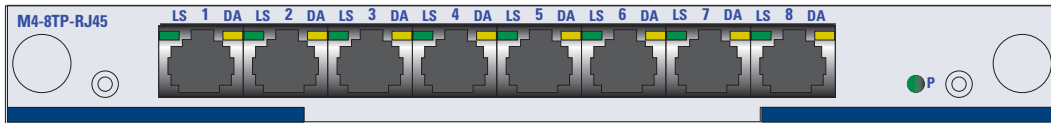

1.7.2 M4-FAST 8-SFP

The M4-FAST 8-SFP media module has 8 × 100BASE-FX ports (SFP slots for mounting SFP transceivers).

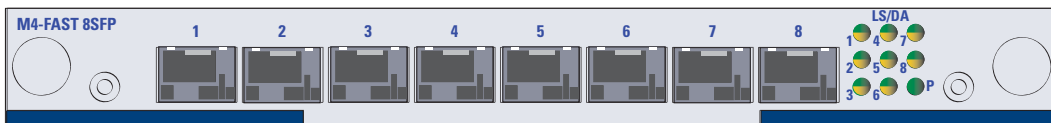

The following Fast Ethernet SFP transceivers are available to you for the M4-FAST 8-SFP media module:

- ▶ Fast Ethernet SFP transceivers:
 - M-FAST SFP-MM/LC
 - M-FAST SFP-SM/LC
 - M-FAST SFP-SM/LC
 - M-FAST SFP-SM+/LC
 - M-FAST SFP-LH/LC

See [“Ethernet ports” on page 31](#).

1.7.3 M4-GIGA 8-SFP

The M4-GIGA 8-SFP media module has 8 × 100/1000BASE-FX ports (SFP slots for mounting SFP transceivers).

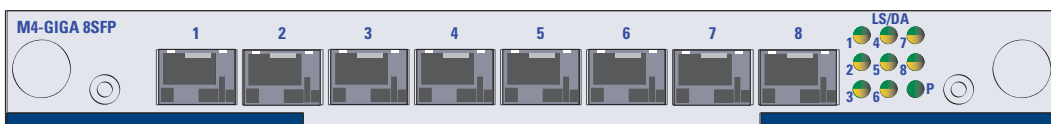

The following SFP transceivers are available to you for the M4-GIGA 8-SFP media module:

- ▶ Gigabit Ethernet SFP transceivers:
 - M-SFP-SX/LC
 - M-SFP-LX/LC

- M-SFP-LX+/LC
 - M-SFP-LH/LC
 - M-SFP-LH+/LC
 - M-SFP-MX/LC
- ▶ Fast Ethernet SFP transceivers:
- M-FAST SFP-MM/LC
 - M-FAST SFP-SM/LC
 - M-FAST SFP-SM+/LC
 - M-FAST SFP-LH/LC

See “Ethernet ports” on page 31.

1.8 SFP/XFP transceiver



Figure 11: SFP transceiver and XFP transceiver
 1 – Fast Ethernet F/O SFP transceiver
 2 – Gigabit Ethernet F/O SFP transceiver
 3 – 10-Gigabit Ethernet F/O XFP transceiver

SFP is the acronym for Small Form-factor Pluggable which is also commonly known as mini-GBIC (GigaBit Interface Converter).

Both Fast Ethernet SFP transceivers and Gigabit Ethernet SFP transceivers are available for your device.

XFP transceivers are slightly larger than SFP transceivers. They support 10-Gigabit Ethernet only.

Note: Use only Hirschmann SFP transceivers or XFP transceivers which are suitable for usage with the device.

1.9 Ethernet ports

1.9.1 10/100/1000 Mbit/s twisted pair port

This port is an RJ45 socket.

The 10/100/1000 Mbit/s twisted pair port allows you to connect network components according to the IEEE 802.3 10BASE-T/100BASE-TX/1000BASE-T standard.

This port supports:

- ▶ Autonegotiation
- ▶ Autopolarity
- ▶ Autocrossing (if autonegotiation is activated)
- ▶ 1000 Mbit/s full duplex
- ▶ 100 Mbit/s half-duplex mode, 100 Mbit/s full duplex mode
- ▶ 10 Mbit/s half-duplex mode, 10 Mbit/s full duplex mode

Delivery state: Autonegotiation activated

The port casing is electrically connected to the front panel.

The pin assignment corresponds to MDI-X.

Figure	Pin	Function
	1	BI_DB+
	2	BI_DB-
	3	BI_DA+
	4	BI_DD+
	5	BI_DD-
	6	BI_DA-
	7	BI_DC+
	8	BI_DC-

Table 10: Pin assignment of a 1000 Mbit/s TP interface in MDI-X mode, RJ45 socket

1.9.2 100 Mbit/s F/O port

This port is an SFP slot.

The 100 Mbit/s F/O port allows you to connect network components according to the IEEE 802.3 100BASE-FX standard.

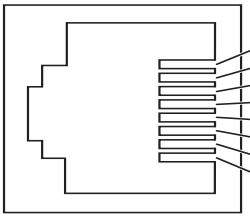
This port supports:

- ▶ Full or half duplex mode

Default setting: Full duplex

1.9.3 1000 Mbit/s F/O port

This port is an SFP slot.

The 1000 Mbit/s F/O port offers you the ability to connect network components according to the IEEE 802.3 100BASE-SX/1000BASE-LX standard.

This port supports:

- ▶ Autonegotiation
- ▶ Full duplex mode

Delivery state: Autonegotiation activated

Note: Make sure that you connect LH ports exclusively with LH ports, SX ports exclusively with SX ports, and LX ports exclusively with LX ports.

1.9.4 10-Gbit/s F/O port

The 10 Gbit/s F/O port allows you to connect network components according to the IEEE 802.3ae 10GBASE-SR/LR standard.

This port supports:

- ▶ Full duplex mode

Default setting: Full duplex

Note: Make sure that you connect SR ports exclusively with SR ports, LR ports exclusively with LR ports, ER ports exclusively with ER ports, and ZR ports exclusively with ZR ports.

1.9.5 Combo ports

You have the option of alternatively connecting a twisted pair cable via a RJ45 socket or an optical fiber via a SFP transceiver to a combo port.

Media type	Connection options			
Twisted pair	Standard	ISO/IEC 8802-03	10BASE-T/100BASE-TX/1000BASE-T	
	Connection type	RJ45		
Fiber optic cable	either	Standard	IEEE 802.3 100BASE-FX	
		Connection type	Fast Ethernet SFP transceiver	
	or	Standard	ISO/IEC 8802-03	1000BASE-SX/LX
		Connection type	1 Gigabit Ethernet SFP transceiver	

Table 11: Combo ports: Connection options

By inserting a SFP transceiver, you deactivate automatically the corresponding twisted pair interface.

1.10 Display elements

After the supply voltage is set up, the Software starts and initializes the device. Afterwards, the device performs a self-test. During this process, various LEDs light up.

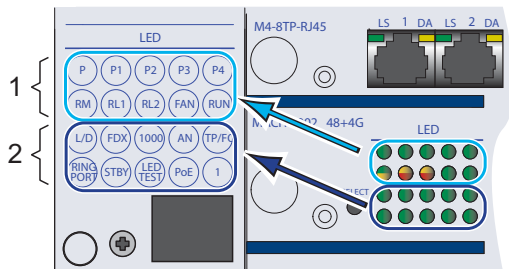

Figure 12: Display elements for device status and port status
 1 - Device status
 2 - Port display status

1.10.1 Device state

These LEDs provide information about conditions which affect the operation of the whole device.

LED	Display	Color	Activity	Meaning
P	Supply voltage	-	none	Supply voltage is too low
		green	lights up	Supply voltage is on
P1	Supply voltage	-	none	No supply voltage 1, or voltage too low, at the plug-in power unit.
		green	lights up	Supply voltage 1 is present at the plug-in power unit.
		green	flashing	Supply voltage 1 is present, but the plug-in power unit is reporting an error.
P2	Supply voltage	-	none	No supply voltage 2, or voltage too low, at the plug-in power unit.
		green	lights up	Supply voltage 2 is present at the plug-in power unit.
		green	flashing	Supply voltage 2 is present, but the plug-in power unit is reporting an error.
P3	Supply voltage	-	none	No supply voltage 3, or voltage too low, at external input 3
		green	lights up	Supply voltage 3 is present at external input 3.
		green	flashing	Supply voltage 3 is present, but the plug-in power unit is reporting an error.

LED	Display	Color	Activity	Meaning
P4	Supply voltage	-	none	No supply voltage 4, or voltage too low, at external input 4.
		green	lights up	Supply voltage 4 is present at external input 4.
		green	flashing	Supply voltage 4 is present, but the plug-in power unit is reporting an error.

LED	Display	Color	Activity	Meaning
RM	Ring Manager	-	none	The RM function is deactivated.
		green	lights up	The RM function is active. The redundant port is disabled.
		green	flashing	The device detects an incorrect configuration of the HIPER-Ring (for example the ring is not connected to the ring port).
		yellow	lights up	The RM function is active. The redundant port is enabled.

LED	Display	Color	Activity	Meaning
RL1	Signal contact - (Relay 1)	-	none	Signal contact 1 is closed, it is not reporting an error, or it was closed via the “Manual setting”.
		yellow	lights up	Signal contact 1 is open. The “Manual setting” is active.
		red	lights up	Signal contact 1 is open, it is reporting an error.

LED	Display	Color	Activity	Meaning
RL2	Signal contact - (Relay 2)	-	none	Signal contact 2 is closed, it is not reporting an error, or it was closed via the “Manual setting”.
		yellow	lights up	Signal contact 2 is open. The “Manual setting” is active.
		red	lights up	Signal contact 2 is open, it is reporting an error.

LED	Display	Color	Activity	Meaning
FAN	Fan	-	none	The plug-in fan unit is installed and at least one fan is reporting an error, or the plug-in fan unit is not installed.
		green	lights up	The plug-in fan unit is installed, and no fan is reporting an error.

LED	Display	Color	Activity	Meaning
RUN	BOOT/ RUN	-	none	The system is in reset mode.
		green	lights up	The system is booting.
		green	lights up	The system is operational.

1.10.2 Port status display

Every media module has one LED per port. The meaning of this port status LED depends on the setting on the basic device. You define the display meaning with the “SELECT” button on the basic device.

- Press the button for approx. 2 seconds to change the meaning of the display. If the button is not pressed for approx. 20 seconds, the display status changes back to “L/D”.

LED	Display	Color	Activity	Meaning
L/D	Link status	green	lights up	The port LEDs of the media modules display the connection status.

LED	Display	Color	Activity	Meaning
FDX	Full duplex/ half duplex	green	lights up	The port LEDs of the media modules display the half-duplex or full-duplex connection status.

LED	Display	Color	Activity	Meaning
1000	10/100/ 1000 Mbit/s	green	lights up	The port LEDs of the media modules display the set transmission speed.

LED	Display	Color	Activity	Meaning
ON	Autonegotia tion	green	lights up	The port LEDs of the media modules display the port configuration type.

LED	Display	Color	Activity	Meaning
RING PORT	Ring port	green	lights up	The port LEDs of the media modules display the HIPER-Ring assignment.

LED	Display	Color	Activity	Meaning
STBY	Stand-by	green	lights up	The port LEDs of the media modules display the assignment to a redundant coupling of network segments.

LED	Display	Color	Activity	Meaning
LED TEST	Light emitting diode test	green	lights up	The status, display status and port status LED test is active. The “RM” LED status flashes green/yellow. The “FAULT” LED status flashes red. The display status LEDs flash green. The port status LEDs of the media modules flash green/yellow.

LED	Display	Color	Activity	Meaning
TP/FO	Twisted pair Fiber optic	green	lights up	The port LEDs of the media modules display the media type.

LED	Display	Color	Activity	Meaning
All display status LEDs	Initialization	green	Running light	The initialization phase is running after a restart.

LED	Display	Color	Activity	Meaning
1	-	green		Service LED

LED	Display	Color	Activity	Meaning
2	PoE status	green	lights up	The port LEDs of the media modules display the PoE (Power over Ethernet) status.

1.10.3 ACA Auto Configuration Adapter

LED	Display	Color	Activity	Meaning
RUN and 1	ACA memory operations	green	Flashing alternately	Error in the memory operation
		green	flashes synchronously 2 × per period	Saves a configuration file from the storage medium ACA to the device.
		green	flashes synchronously 1 × per period	Saves a configuration file from the device to the storage medium ACA.

Port status

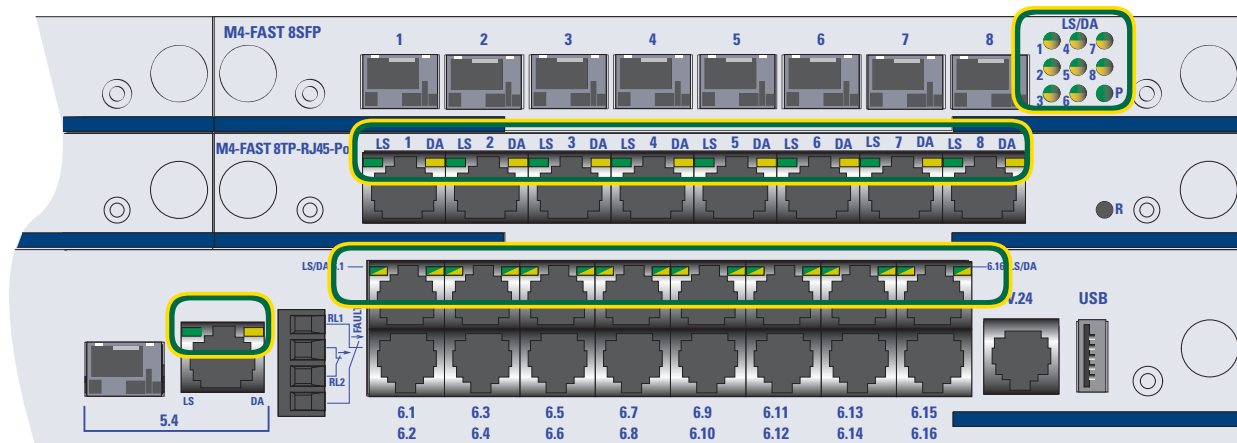

These LEDs provide port-related information. For each port, the following are available:

- ▶ 2 × single-color LED
- ▶ 1 × bi-color LED

You set the content of the information with the button on the basic device. See [“Port status display” on page 35](#).

LED	Display	Color	Activity	Meaning
1 ... n	Link status	-	none	Device detects an invalid or missing link
		green	lights up	Device detects a valid link
		green	flashes 1 time a period	Port is switched to stand-by
		green	flashes 3 times a period	Port is switched off
	Data traffic	yellow	flashing	Device is transmitting and/or receiving data

LED	Display	Color	Activity	Meaning
1 ... n	FDX	-	none	The half-duplex connection type is active
		green	lights up	The full-duplex connection type is active

LED	Display	Color	Activity	Meaning
1 ... n	Transmission speed	-	none	Transmission speed 10 Mbit/s is active.
		green	lights up	Transmission speed 100 Mbit/s is active.
		yellow	lights up	Transmission speed 1000 Mbit/s is active.
		green/yellow	flashing	Transmission speed 10000 Mbit/s is active.

LED	Display	Color	Activity	Meaning
1 ... n	Autonegotiation	green	lights up	Autonegotiation is active.

LED	Display	Color	Activity	Meaning
1 ... n	Twisted pair Fiber optic	-	none	Autoselect, no medium has been selected.
		green	lights up	Twisted pair has been selected. The port LEDs of the media modules display the twisted pair ports.
		yellow	lights up	Fiber optic has been selected. The port LEDs of the media modules display the F/O ports.

LED	Display	Color	Activity	Meaning
1 ... n	RING PORT	green	lights up	This port is assigned to the HIPER-Ring.

LED	Display	Color	Activity	Meaning
1 ... n	Stand-by	green	lights up	Connection port for the data line.
		yellow	lights up	Connection port for the control line.
		green/yellow	flashing	No stand-by partner available.

LED	Display	Color	Activity	Meaning
1 ... n	LED TEST	green	lights up	The LED is not operating.
		green/yellow	flashing	The LED test is active.

LED	Display	Color	Activity	Meaning
1 ... n	PoE	-	none	No PoE port available or: Power over Ethernet function is disabled (PoE port status = disabled).
		green	lights up	A PoE terminal device is registered and is receiving power via PoE.
		yellow	lights up	The Power over ETHERNET function is enabled, but no voltage is supplied via PoE.

1.11 Management interfaces

1.11.1 V.24 interface (external management)

The V.24 interface is an RJ11 socket.

The V.24 user interface is serial and allows you to connect the following devices directly:

- ▶ External management station (VT100 terminal or PC with appropriate terminal emulation). With this management station, the Command Line Interface (CLI) is available to you. Furthermore, the system monitor is available to you at the system start.

VT100 terminal settings	
Speed	9600 Baud
Data	8 bit
Stopbit	1 bit
Handshake	off
Parity	none

The interface casing is electrically connected to the front panel.

The V.24 interface is not electrically insulated from the supply voltage.

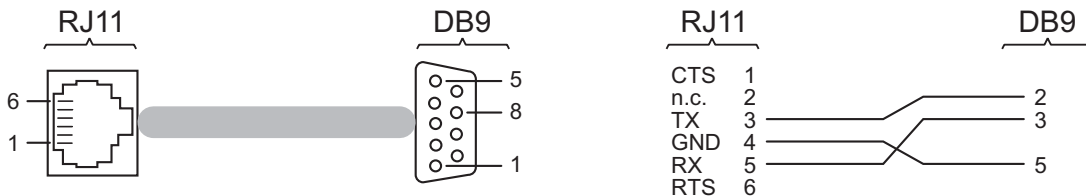

Figure 13: Pin assignment of the V.24 interface and the DB9 plug

You will find the order number for the terminal cable, which is ordered separately, in the Technical Data section ([see on page 55 “Technical data”](#)).

1.11.2 USB interface

The USB interface allows you to connect the AutoConfiguration Adapter ACA22 storage medium. This is used for saving/loading the configuration data and diagnostic information, and for loading the software.

[See “Accessories” on page 66.](#)

Figure	Pin	Function
	1	VCC (VBus)
	2	- Data
	3	+ Data
	4	Ground (GND)

Table 12: Pin assignment of the USB interface

2 Installation

On delivery, the device is ready for operation.

The following procedure has been proven to be successful for the assembly of the device:

- ▶ [Checking the package contents](#)
- ▶ [Installing the device and grounding](#)
- ▶ [Mounting the power supply unit on the back of the MACH4002 device](#)
- ▶ [Mounting the power unit chassis, connecting with the MACH4002 device](#)
- ▶ [Installing the M4-AIR... plug-in fan unit](#)
- ▶ [Installing the plug-in power units in the M4-POWER power unit chassis](#)
- ▶ [Installing media modules](#)
- ▶ [Installing an SFP transceiver \(optional\)](#)
- ▶ [Connecting the supply voltage](#)
- ▶ [Wiring and installing the signal contact](#)
- ▶ [Connecting data cables](#)

Note: Note the safety instructions in [“General safety instructions” on page 7](#).

2.1 Checking the package contents

- Check whether the package includes all items named in the section [“Scope of delivery” on page 64](#).
- Check the individual parts for transport damage.

2.2 Installing the device and grounding

You have the option of assembling the device on a flat surface or in a 19" standard switch cabinet.

2.2.1 Selecting the assembly location

 CAUTION
OVERHEATING OF THE DEVICE
When installing the device, ensure that the ventilation slots are not covered. Failure to follow these instructions can result in injury or equipment damage.

Select the assembly location according to the safety guidelines ([see on page 7 “Safety instructions”](#)).

When selecting the assembly location, also make sure the following requirements are met:

- ▶ The assembly location can be accessed for maintenance and repair work.
- ▶ The LED display elements are clearly visible.
- ▶ Twisted pair cables are at a sufficient distance from potential sources of electrical interference, such as power supply cables.
- ▶ The device has a separate power source with a ground connection. The power supply can be interrupted by means of a separate isolator or power switch. We recommend using overvoltage protection for all devices.

Note: The shielding ground of the connectable twisted pair cables is connected to the front panel as a conductor.

2.2.2 Mounting on a flat surface

Before operating the device on a flat surface, such as a table, stick the supplied casing feet onto the bottom of the device, with approx. 0.8 in (2 cm) of space from the corners.

- If necessary, remove any dirt from the bottom of the device where you want to place the stick-on feet.
- Remove the protective foil from the adhesive surface of a casing foot and attach the casing foot on the device.

2.2.3 Mounting in a switch cabinet

The devices are designed to be mounted in a 19" switch cabinet. By mounting your MACH4002 device in a 19" switch cabinet on sliding/mounting rails, you provide a more stable position for your device in environments subject to vibration.

Note: For more information on sliding/mounting rails and how to install them, please contact your switch cabinet manufacturer.

If you are operating the device in a 19" switch cabinet, you must install sliding/mounting rails (not included in the delivery) to hold the weight of the device.

NOTE

VIBRATIONS

Assemble the device in a 19" switch cabinet on sliding/mounting rails.

Non-adherence to these instructions can lead to material damage.

- Ensure adequate ventilation. If necessary, install an additional fan in the switch cabinet to prevent the device from overheating.
- Measure the depth of the 19" switch cabinet so as to allow the power supply cables to be fitted at the back and the data cables to be fitted at the front.
- Assemble the sliding or mounting rails in the 19" switch cabinet as specified by the manufacturer.

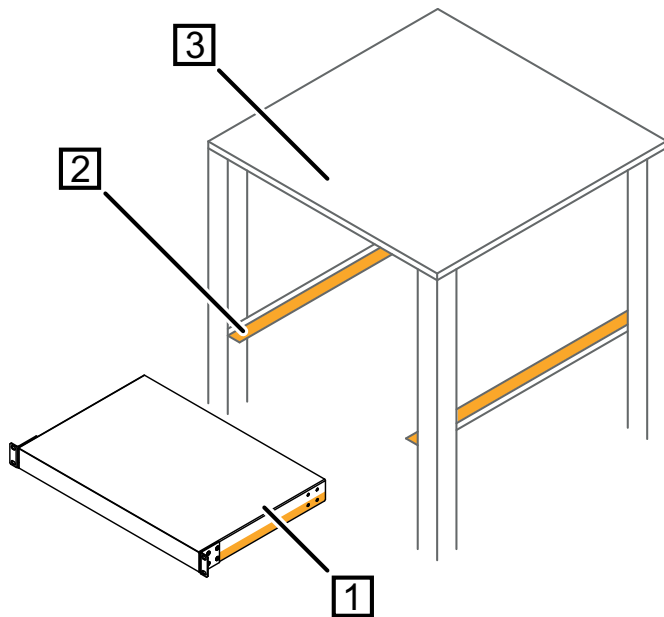
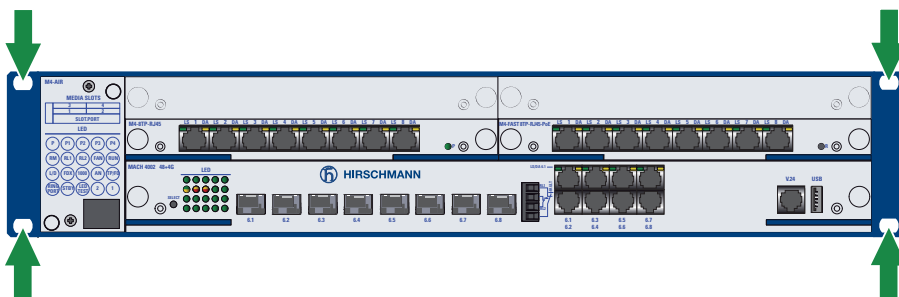

Figure 14: Assembly in a switch cabinet with sliding/mounting rails
 1 - MACH4002 device
 2 - Sliding/mounting rail
 3 - 19" switching cabinet

On delivery, 2 mounting brackets are mounted to the sides of the device (see figure below).



- Fasten the device in the switch cabinet by screwing it in with the mounting brackets.

2.2.4 Grounding the device

The device is grounded via the power supply connections.

Note: The shielding ground of the connectable twisted pairs lines is connected to the front panel as a conductor.

When the device is being operated via the 230/120 V AC power supply unit, it is grounded via the safety plug. When it is being operated with external DC voltage via the

M4-POWER connections, the device is grounded via the M4-POWER connection.

2.3 Mounting the power supply unit on the back of the MACH4002 device



- Remove the cover panel.
- Slide the power supply unit all the way into the basic device along the mounting rails above and below.
- Make sure that there is a good connection between the multiple plug of the plug-in power unit and the female multipoint of the system bus.
- Screw the four slotted-head screws in the front panel of the plug-in power unit flush with the frame of the basic device.

2.4 Mounting the power unit chassis, connecting with the MACH4002 device

NOTICE

SHORT-CIRCUIT

Insert the plugs of the power supply cables in straight in order to avoid the bridging of pins on the power supply connection of the MACH4002 device.

Non-adherence to these instructions can lead to material damage.

Note: The power supply cables between the M4-POWER power unit chassis and the MACH4002 device are not hot-swappable.

Note: The power supply cables between the M4-POWER power unit chassis and the MACH4002 device carry system-internal safety extra-low voltages. Only use the M4-POWER CABLE and the M4-POWER power unit chassis for the redundant power supply. Do not connect any other external voltage source.

Consider the sequence for the cabling of the power unit chassis and the MACH4002 device:

- Separate the external power supply from the M4-POWER power unit chassis.
- Remove all the plug-in power units from the M4-POWER power unit chassis.
- Connect one end of the M4-POWER CABLE to the MACH4002 device.
- Connect the other end of the M4-POWER CABLE to the M4-POWER power unit chassis.
- Connect the MACH4000 device and the M4-POWER power unit chassis with the mounting bracket included in the delivery.
- Slot all the plug-in power units into the M4-POWER power unit chassis.
- Connect the external power supply (AC or DC, depending on the plug-in power unit) with the M4-POWER power unit chassis.

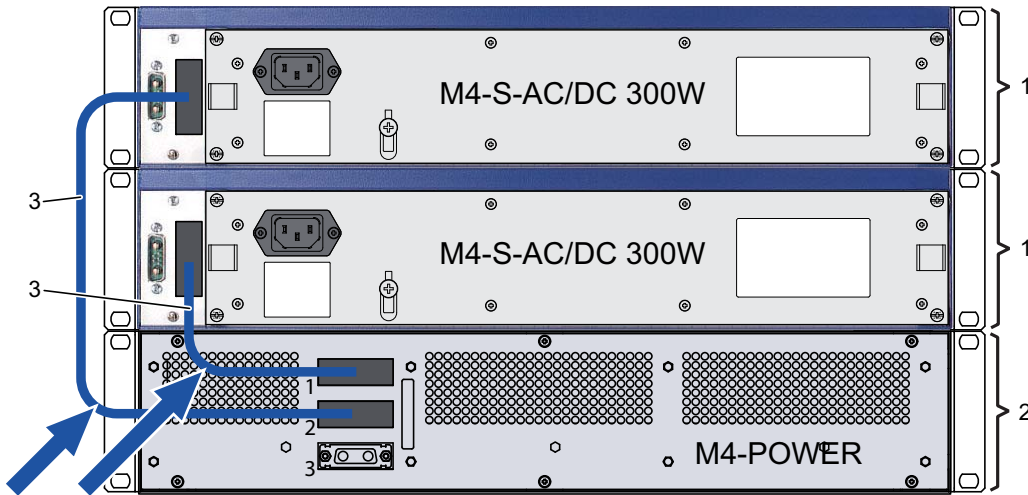

Figure 15: Redundant power supply via the M4-POWER power unit chassis.
 Step 1: Connect MACH4002 device(s) to M4-POWER
 1 - MACH4002, back
 2 - M4-POWER power unit chassis, back
 3 - Not hot-swappable

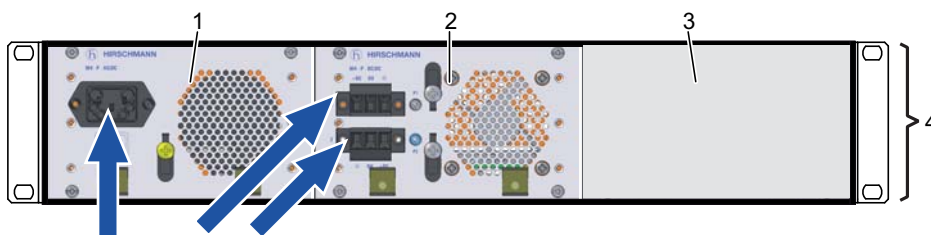

Figure 16: Redundant power supply via the M4-POWER power unit chassis.
 Step 2: Connecting M4-POWER to the power supply (example:
 configuration with 2 plug-in power units)
 1 - Plug-in power unit 1
 2 - Plug-in power unit 2
 3 - Not used
 4 - M4-POWER power unit chassis, front of device

2.5 Installing the M4-AIR... plug-in fan unit

- Slide the new plug-in fan unit all the way into the basic device along the mounting rails above and below.
- Make sure that there is a good connection between the multiple plug of the plug-in fan unit and the female multipoint of the system bus.
- Screw the two knurled screws in the front panel of the plug-in fan unit with the frame of the basic device.

2.6 Installing the plug-in power units in the M4-POWER power unit chassis



When replacing a defective plug-in power unit, only use a plug-in power unit of the M4-P-... 300W type ([see on page 65 “Order numbers/product description”](#))

- Remove the power supply cables.
- Loosen the four screws used to fasten the plug-in power unit in the basic device and pull the unit out of the basic device, or remove the cover plate of the power unit slot.
- Slide the new plug-in power unit all the way into the basic device along the mounting rails above and below.
- Make sure that there is a good connection between the multiple plug of the plug-in power unit and the female multipoint of the system bus.
- Screw the slotted-head screws in the front panel of the plug-in power unit flush with the frame of the basic device.
- Connect the power supply cables.

Note: The tightening torque:

- ▶ 0.79 Nm (7 lb-in) for input connections.
- ▶ 1.24 Nm (11 lb-in) for input connections.

2.7 Installing media modules

The switch has 4 inputs for connecting media modules.

The number of connectible network segments depends on the number of media modules installed. If the full 4 media modules with 8 ports each are connected, then in addition to the ports of the basic board, you get a further 32 ports for connecting network segments.

The modular design of the device allows you to easily expand the network yourself by installing the desired media modules.

The media modules can be installed in the devices, or de-installed, while the network is operating (hot-swappable).

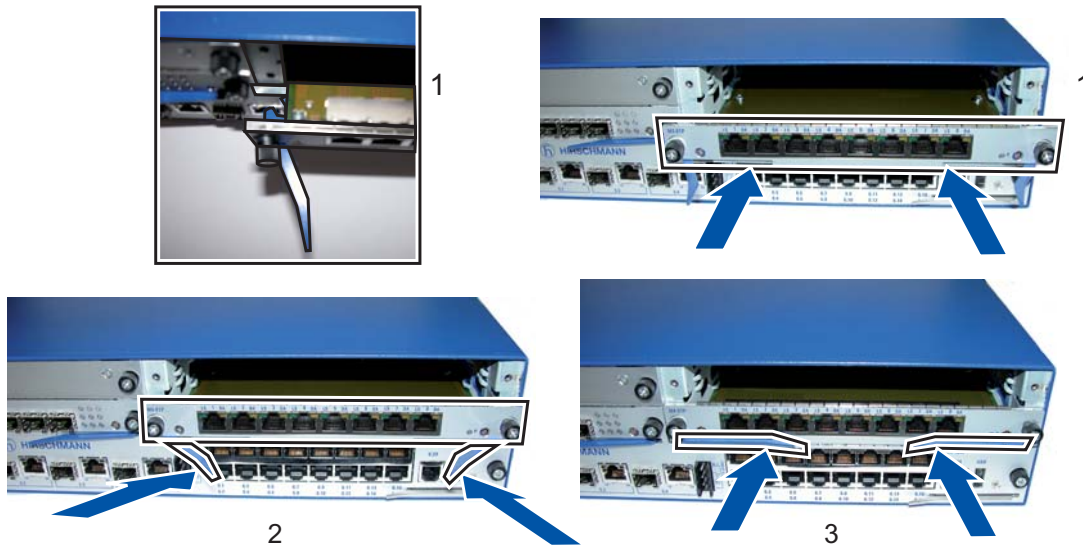

Figure 17: Installing the media modules

1 - Step 1

2 - Step 2

3 - Step 3

Note: Note the “ESD Guidelines” on page 8 and “General safety instructions” on page 7 ff.

- Close the whole of the front surface beside the media modules with cover panels. This provides optimal shielding and convection. The slots for the media modules are all the same. They can be selected in any order.
- Remove the cover panel from the media module slot on the basic device.
- Note the positions of the blue insertion catches (see the figure above, step 1).
- Insert the media module almost as far as it will go into the desired slot (see figure above, step 2).
- Make sure that there is a good connection between the multiple plugs of the media module and the female multipoints of the system bus.
- Insert the media module as far as it will go into the desired slot by closing the blue insertion catches (see figure above, step 3).
- Screw the two knurled screws in the front panel of the media module flush with the frame of the basic device.

2.8 Installing an SFP transceiver (optional)

Prerequisites:

Exclusively use Hirschmann SFP transceivers.

See [“Accessories” on page 66](#).

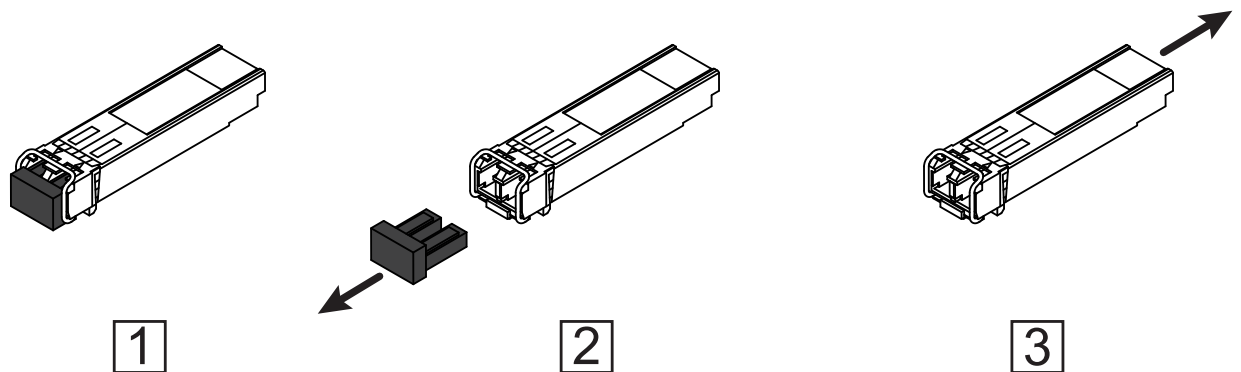

Figure 18: Installing SFP transceivers: Installation sequence

Proceed as follows:

- Take the SFP transceiver out of the transport packaging (1).
- Remove the protection cap from the SFP transceiver (2).
- Push the SFP transceiver with the lock closed into the slot until it latches in (3).

2.9 Connecting the supply voltage

WARNING

ELECTRIC SHOCK

Start connecting electrical wires only if all safety requirements listed in chapter [“Supply voltage”](#) are fulfilled.

Failure to follow these instructions can result in death, serious injury, or equipment damage.

Remarks:

- ▶ Observe the information about the voltages to be connected: [“Technical data” on page 55](#)
- ▶ For the AC input of the AC/DC plug-in power units, use a nominal rating of not more than 16 A - slow-blow characteristic.

- ▶ For the DC input of the DC plug-in power units at P1 and P2, use a nominal rating of not more than 20 A - slow-blow characteristic.
- ▶ Do not use a redundant power supply at P1 and P2 simultaneously if one of the “+” connections of P1 or P2 is grounded.
- ▶ For the redundant power supply, only use voltage sources whose negative terminal is grounded.
- ▶ For the current conductors at the voltage input of the DC plug-in power units, use a cable cross-section of at least 2.5 mm² (North America: AWG12).
- ▶ For the current conductors at the voltage input of the AC/DC plug-in power units, use a cable cross-section of at least 1.0 mm² (North America: AWG16).

 **WARNING**

This applies exclusively to device variants with a DC power supply:

FIRE HAZARD

Install a back-up fuse in both of the input voltage conductors if the negative terminal of the voltage source power is not grounded.

Use a back-up fuse suitable for DC.

Failure to follow this instruction can result in death, serious injury, or equipment damage.

- Connect the power supply cable to the power input.
- Install strain relief.
- Switch on the plug-in power units to start up the device.

2.10 Wiring and installing the signal contact

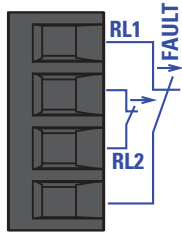

Figure 19: 4-pin signal contact

The potential-free signal contact (relay contact, closed circuit) reports through a break in contact:

- ▶ At least one power supply is inoperable.
- ▶ The device is not operational.
- ▶ The failure of the connection on at least one port.
The report of the link status can be masked by the Management for each port. In the delivery state is deactivated.
- ▶ Loss of the ring redundancy reserve.
- ▶ A detected error during the self-test.

The following conditions are reported in standby mode:

- ▶ Control cable interrupted
- ▶ Control cable short-circuited
- ▶ Partner device is in standby mode

The following conditions are reported in normal mode:

- ▶ Control cable short-circuited
- ▶ Partner device is in normal mode

The following condition is also reported in RM mode:

- ▶ Ring redundancy reserve is available. On delivery, there is no ring redundancy monitoring.

- Pull the terminal block off the device and connect the signal lines.
- Mount the terminal block for the 2 signal contacts on the front side of the device. Make sure that the snap lock snaps into place.

Note: The torque for tightening the terminal block for the signal contact on the device is 3 lb-in (0.34 Nm).

You can use the Management to set the signal contact manually and thus control external devices.

2.11 Connecting data cables

You can connect end devices and other segments to the device ports using twisted pair cables or optical fibers (F/O).

Note: Verify that you connect only optical ports with the same optical transmission properties with each other.

Note the following general recommendations for data cable connections in environments with high electrical interference levels:

- Keep the length of the data cables as short as possible.
- Use optical data cables for the data transmission between the buildings.
- When using copper cables, provide a sufficient separation between the power supply cables and the data cables. Ideally, install the cables in separate cable channels.
- Verify that power supply cables and data cables do not run parallel over longer distances. To reduce inductive coupling, verify that the power supply cables and data cables cross at a 90° angle.
- Use shielded data cables for gigabit transmission via copper cables, for example SF/UTP cables according to ISO/IEC 11801. Exclusively use shielded data cables to meet EMC requirements according to EN 50121-4 and marine applications.
- Connect the data cables according to your requirements.
[See “Ethernet ports” on page 31.](#)

3 Making basic settings

WARNING

UNINTENTIONAL OPERATION IN DEVICE

Install and maintain a process that assigns a unique IP address to every device in the network.

Failure to follow these instructions can result in death, serious injury, or equipment damage.

The IP parameters must be entered when the device is installed for the first time. The device provides 6 options for configuring the IP addresses:

- ▶ Entry via V.24 connection
- ▶ Configuration via BOOTP
- ▶ Configuration via DHCP
- ▶ Configuration via DHCP (Option 82)
- ▶ AutoConfiguration Adapter

Further information on the basic settings of the device can be found in the “Basic Configuration” user manual.

■ **Default settings**

- ▶ IP address: The device looks for the IP address using DHCP
- ▶ Password for management:
 - Login: user; password: public (read only)
 - Login: admin; password: private (read and write)
- ▶ V.24 data rate: 9600 Baud
- ▶ Ring redundancy: disabled
- ▶ Ethernet ports: link status is not evaluated (signal contact)
- ▶ Optical 100 Mbit/s ports: 100 Mbit/s full duplex
- ▶ Optical 10 Gbit/s ports: 10 Gbit/s full duplex
- ▶ All other ports: autonegotiation
- ▶ Ring manager disabled
- ▶ Stand-by coupling: disabled

4 Maintenance and service

- When designing this device, Hirschmann largely avoided using high-wear parts. The parts subject to wear and tear are dimensioned to last longer than the lifetime of the product when it is operated normally. Operate this device according to the specifications.
- Relays are subject to natural wear. This wear depends on the frequency of the switching operations. Check the resistance of the closed relay contacts and the switching function depending on the frequency of the switching operations.
- Hirschmann is continually working on improving and developing their software. Check regularly whether there is an updated version of the software that provides you with additional benefits. You find information and software downloads on the Hirschmann product pages on the Internet (<http://www.hirschmann.com>).
- Depending on the degree of pollution in the operating environment, check at regular intervals that the ventilation slots in the device are not obstructed.

Note: You find information on settling complaints on the Internet at <http://www.beldensolutions.com/en/Service/Repairs/index.phtml>.

5 Deinstallation

5.1 Removing a media module

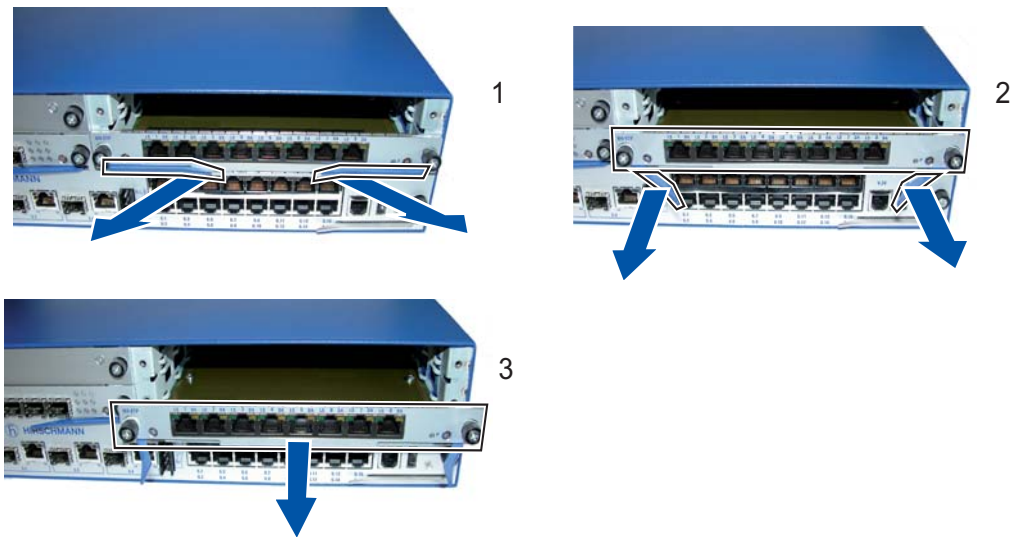

Figure 20: Deinstalling the media modules

- 1 - Step 1
- 2 - Step 2
- 3 - Step 3

Note: Note the “[ESD Guidelines](#)” on page 8 and “[General safety instructions](#)” on page 7 ff.

- Lever the selected media module from the slot by pulling the blue insertion catches (see figure above, steps 1 and 2).
- Pull the media module out of the slot (see figure above, step 3).
- Close the media module slot on the basic device using a cover panel.
- Screw the four knurled screws in the cover panel flush with the frame of the basic device.

5.2 Removing an SFP transceiver (optional)

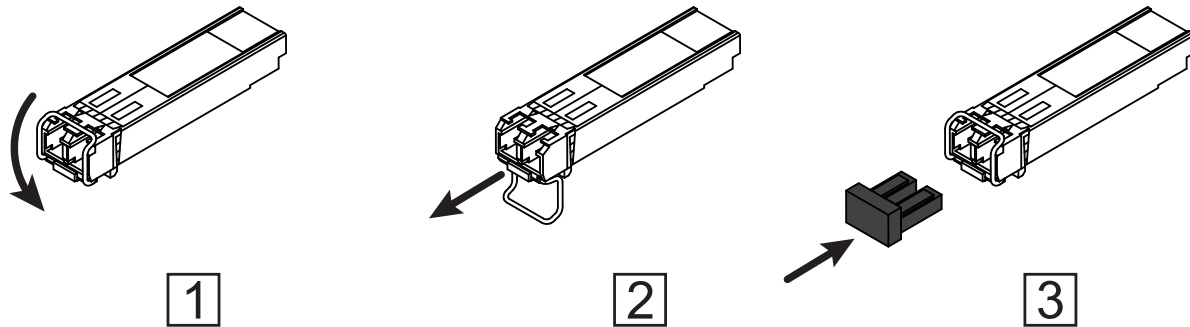

Figure 21: De-installing SFP transceivers: De-installation sequence

Proceed as follows:

- Open the locking mechanism of the SFP transceiver (1).
- Pull the SFP transceiver out of the slot via the open locking mechanism (2).
- Close the SFP transceiver with the protection cap (3).

5.3 Deinstalling the M4-AIR... plug-in fan unit

CAUTION

ROTATING PARTS

After the device is switched off, the fan blades continue rotating for a number of seconds. Do not reach into a rotating fan!

Failure to follow these instructions can result in injury or equipment damage.

- Remove the 2 screws in the front panel of the M4-AIR plug-in fan unit.
- Pull the plug-in fan unit out a few centimeters and wait until the fan comes to a halt before pulling it all the way out.

6 Technical data

6.1 General technical data

Dimensions	MACH4002-...	W x H x D: 480 mm × 88 mm × 435 mm
	M4-POWER	W x H x D: 480 mm × 88 mm × 435 mm
Assembly	MACH4002-...	19" switch cabinet
	M4-POWER	19" switch cabinet
Weight	MACH4002-...	7.5 kg
Power supply	MACH4002-...	Power supply unit M4-S-xx or power supply unit basic device M4-POWER with power supply unit M4-P-xx (sold separately)
Supply voltage	M4-S-AC/DC 300W	Rated voltage: 100 V AC ... 240 V AC, 50 Hz ... 60 Hz Voltage range: 90 V AC ... 265 V AC, 47 Hz ... 63 Hz
	M4-P-AC/DC 300W	Rated voltage: 100 V AC ... 240 V AC, 50 Hz ... 60 Hz Voltage range: 90 V AC ... 265 V AC, 47 Hz ... 63 Hz
Current consumption	M4-S-AC/DC 300W	max. 1.7 A (240 V AC), max. 4.0 A (100 V AC)
	M4-P-AC/DC 300W	max. 1.7 A (240 V AC), max. 4.0 A (100 V AC)
Activation current	M4-S-AC/DC 300W	typ. <40.0 A at 265 V AC and cold start
	M4-P-AC/DC 300W	typ. <40.0 A at 265 V AC and cold start
Overload current protection at input		Non-replaceable fuse
Potential difference between input voltage and casing	M4-...-...VDC 300W	Potential difference from input voltage +24 V DC/+48 V DC: 60 V DC Potential difference from input voltage 0 V: 60 V DC ^a
Signal contact ("FAULT")	Switching current	max. 1 A, SELV or ES1
	Switching voltage	max. 60 V DC or max. 30 V AC, SELV or ES1 To the front panel, power supply, other inputs/ outputs: max. 1500 V DC
	Insulation voltage	
Environment	Storage temperature	Ambient air: -25 °C ... +70 °C (-13 °F ... +158 °F)
	Humidity	10 % ... 95 % (non-condensing)
	Air pressure	up to 6562 ft (2000 m; 795 hPa), higher altitudes upon request
Operating temperature	MACH4002-... M4-S-xx, M4-P-xx M-SFP-xx/xx M-XFP-xx/xx M-FAST SFP-xx/xx M4-8TP-RJ45 M4-FAST 8-SFP M4-GIGA 8-SFP	With fan plug-in unit M4-AIR: Ambient air temperature 0 °C ... +60 °C (+32 °F ... +140 °F)
Pollution degree		2
Protection classes	Laser protection	Class 1 according to EN 60825-1
	Protection class	IP20

- a. The 0 V connections within a DC module (M4-...-...VDC 300W) are connected with each other.

6.2 Dimension drawings

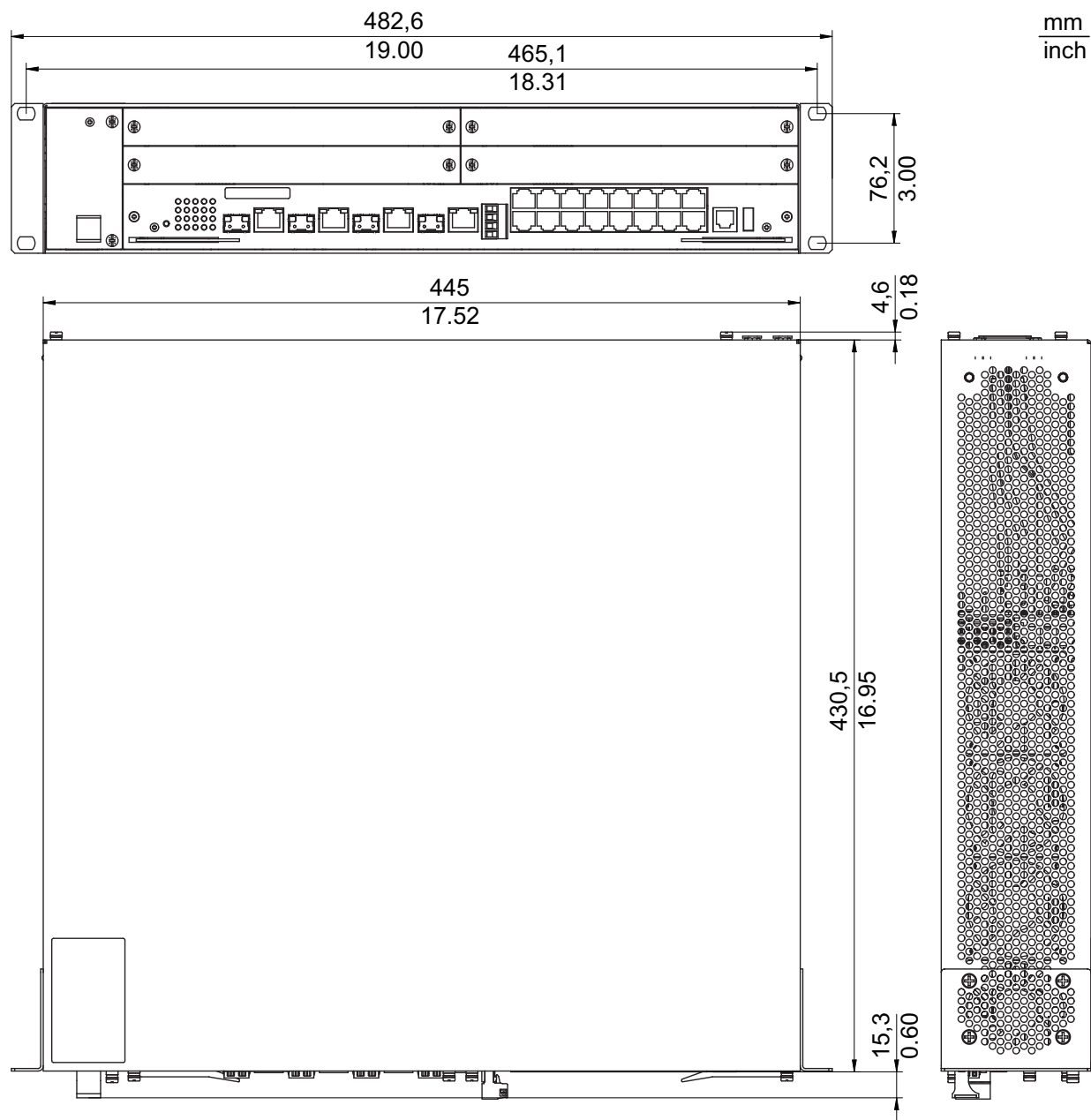

Figure 22: Dimensions

6.3 Interfaces

Device	Interface	Version
MACH4002-...	Signal contact	4-pin pluggable terminal block
	V.24 access	1 × RJ11 socket
	USB interface	for connecting an AutoConfiguration Adapter ACA22.

6.4 EMC and immunity

EMC interference immunity		
IEC/EN 61000-4-2	Electrostatic discharge	
	Contact discharge	6 kV
	Air discharge	8 kV
IEC/EN 61000-4-3	Electromagnetic field 80 - 2,700 MHz	max. 10 V/m
IEC/EN 61000-4-4	Fast transients (burst)	
	- Power line - Data line	2 kV 4 kV
IEC/EN 61000-4-5	Voltage surges	
	- Power line, line/line:	2 kV
	- Power line, line/earth	2 kV
	- Data line	4 kV
IEC/EN 61000-4-6	Line-conducted interference voltages 150 kHz - 80 MHz	10 V
EN 61000-4-9	Pulse magnetic fields	300 A/m

EMC interference emission		
EN 55032	Class A	Yes
FCC 47 CFR Part 15	Class A	Yes
German Lloyd	Classification + Construction Guidelines VI-7-3 Part 1 Ed. 2001	Yes

Stability		
Vibration	IEC 60068-2-6 Test FC test level according to IEC 61131-2	Yes
	Germanischer Lloyd Guidelines for the Performance of Type Tests Part 1	Yes
Shock	IEC 60068-2-27 Test Ea test level according to IEC 61131-2	Yes

6.5 Network range

6.5.1 10/100/1000 Mbit/s twisted pair port

10/100/1000 Mbit/s twisted pair port

Length of a twisted pair segment max. 328 ft (100 m) (for Cat5e cable)

Table 13: Network range: 10/100/1000 Mbit/s twisted pair port

6.5.2 Fast Ethernet SFP transceiver

Product code	Mode ^a	Wave length	Fiber	System attenuation	Example for F/O line length ^b	Fiber attenuation	BLP/Dispersion
M-FAST-SFP-MM/LC...	MM	1310 nm	50/125 μm	0 dB ... 8 dB	0 mi ... 3.11 mi (0 km ... 5 km)	1.0 dB/km	800 MHz×km
M-FAST-SFP-MM/LC...	MM	1310 nm	62.5/125 μm	0 dB ... 11 dB	0 mi ... 2.49 mi (0 km ... 4 km)	1.0 dB/km	500 MHz×km
M-FAST-SFP-SM/LC...	SM	1310 nm	9/125 μm	0 dB ... 13 dB	0 mi ... 15.53 mi (0 km ... 25 km)	0.4 dB/km	3.5 ps/(nm×km)
M-FAST-SFP-SM+/LC...	SM	1310 nm	9/125 μm	10 dB ... 29 dB	15.53 mi ... 40.39 mi (25 km ... 65 km)	0.4 dB/km	3.5 ps/(nm×km)
M-FAST-SFP-LH/LC...	SM	1550 nm	9/125 μm	10 dB ... 29 dB	29.20 mi ... 64.62 mi (47 km ... 104 km)	0.25 dB/km	19 ps/(nm×km)
M-FAST-SFP-LH/LC...	SM	1550 nm	9/125 μm	10 dB ... 29 dB	14.29 mi ... 86.99 mi (55 km ... 140 km)	0.18 dB/km ^c	18 ps/(nm×km)
SFP-FAST-MM/LC ^d	MM	1310 nm	50/125 μm	0 dB ... 8 dB	0 mi ... 3.11 mi (0 km ... 5 km)	1.0 dB/km	800 MHz×km
SFP-FAST-MM/LC EEC ^d	MM	1310 nm	62.5/125 μm	0 dB ... 11 dB	0 mi ... 2.49 mi (0 km ... 4 km)	1.0 dB/km	500 MHz×km

Table 14: F/O port 100BASE-FX (SFP Fiber Optic Fast Ethernet Transceiver)

Product code	Mode ^a	Wave length	Fiber	System attenuation	Example for F/O line length ^b	Fiber attenuation	BLP/Dispersion
SFP-FAST-SM/LC ^d	SM	1310 nm	9/125 µm	0 dB ... 13 dB	0 mi ... 15.53 mi (0 km ... 25 km)	0.4 dB/km	3.5 ps/(nm×km)
SFP-FAST-SM/LC EEC ^d	SM	1310 nm	9/125 µm	0 dB ... 13 dB	0 mi ... 15.53 mi (0 km ... 25 km)	0.4 dB/km	3.5 ps/(nm×km)

Table 14: F/O port 100BASE-FX (SFP Fiber Optic Fast Ethernet Transceiver)

- a. MM = Multimode, SM = Singlemode, LH = Singlemode Longhaul
- b. Including 3 dB system reserve when compliance with the fiber data is observed.
- c. With ultra-low-loss optical fiber.
- d. You will find further information on certifications on the Internet on the Hirschmann product pages (www.hirschmann.com).

6.5.3 Bidirectional Fast Ethernet SFP transceiver

Product code	Mode ^a	Wave length TX	Wave length RX	Fiber	System attenuation	Example for F/O line length ^b	Fiber attenuation	BLP/Dispersion
SFP-FAST-BA MM/LC EEC	MM	1310 nm	1550 nm	50/125 µm 62.5/125 µm	0 dB ... 16 dB	0 mi ... 1.24 mi (0 km ... 2 km)	1.0 dB/km	800 MHz×km 500 MHz×km
SFP-FAST-BB MM/LC EEC	MM	1550 nm	1310 nm	50/125 µm 62.5/125 µm	0 dB ... 16 dB	0 mi ... 1.24 mi (0 km ... 2 km)	1.0 dB/km	800 MHz×km 500 MHz×km
SFP-FAST-BA SM/LC EEC	SM	1310 nm	1550 nm	9/125 µm	0 dB ... 18 dB	0 km ... 12.43 mi (0 km ... 20 km)	0.4 dB/km	3.5 ps/(nm×km)
SFP-FAST-BB SM/LC EEC	SM	1550 nm	1310 nm	9/125 µm	0 dB ... 18 dB	0 km ... 12.43 mi (0 km ... 20 km)	0.25 dB/km	19 ps/(nm×km)
SFP-FAST-BA SM+/LC EEC	SM	1310 nm	1550 nm	9/125 µm	0 dB ... 29 dB	0 mi ... 37.29 mi (0 km ... 60 km)	0.4 dB/km	3.5 ps/(nm×km)
SFP-FAST-BB SM+/LC EEC	SM	1550 nm	1310 nm	9/125 µm	0 dB ... 29 dB	0 mi ... 37.29 mi (0 km ... 60 km)	0.25 dB/km	19 ps/(nm×km)

Table 15: F/O port (bidirectional Fast Ethernet SFP transceiver)

- a. MM = Multimode, SM = Singlemode, LH = Singlemode Longhaul
- b. Including 3 dB system reserve when compliance with the fiber data is observed.

6.5.4 Gigabit Ethernet SFP transceiver

Product code	Mode ^a	Wave length	Fiber	System attenuation	Example for F/O line length ^b	Fiber attenuation	BLP/Dispersion
M-SFP-SX/LC...	MM	850 nm	50/125 μm	0 dB ... 7.5 dB	0 mi ... 0.34 mi (0 km ... 0.55 km)	3.0 dB/km	400 MHz×km
M-SFP-SX/LC...	MM	850 nm	62.5/125 μm	0 dB ... 7.5 dB	0 mi ... 0.17 mi (0 km ... 0.275 km)	3.2 dB/km	200 MHz×km
M-SFP-MX/LC...	MM	1310 nm	50/125 μm	0 dB ... 12 dB	0 mi ... 0.93 mi (0 km ... 1.5 km)	1.0 dB/km	800 MHz×km
M-SFP-MX/LC...	MM	1310 nm	62.5/125 μm	0 dB ... 12 dB	0 mi ... 31.06 mi (0 km ... 50 km)	1.0 dB/km	500 MHz×km
M-SFP-LX/LC...	MM	1310 nm ^c	50/125 μm	0 dB ... 10.5 dB	0 mi ... 0.34 mi (0 km ... 0.55 km)	1.0 dB/km	800 MHz×km
M-SFP-LX/LC...	MM	1310 nm ^d	62.5/125 μm	0 dB ... 10.5 dB	0 mi ... 0.34 mi (0 km ... 0.55 km)	1.0 dB/km	500 MHz×km
M-SFP-LX/LC...	SM	1310 nm	9/125 μm	0 dB ... 10.5 dB	0 mi ... 12.43 mi (0 km ... 20 km) ^e	0.4 dB/km	3.5 ps/(nm×km)
M-SFP-LX+/LC...	SM	1310 nm	9/125 μm	5 dB ... 20 dB	8.70 mi ... 26.10 mi (14 km ... 42 km)	0.4 dB/km	3.5 ps/(nm×km)
M-SFP-LH/LC...	LH	1550 nm	9/125 μm	5 dB ... 22 dB	14.29 mi ... 49.71 mi (23 km ... 80 km)	0.25 dB/km	19 ps/(nm×km)
M-SFP-LH+/LC	LH	1550 nm	9/125 μm	15 dB ... 30 dB	44.12 mi ... 67.11 mi (71 km ... 108 km)	0.25 dB/km	19 ps/(nm×km)
M-SFP-LH+/LC	LH	1550 nm	9/125 μm	15 dB ... 30 dB	44.12 mi ... 79.54 mi (71 km ... 128 km)	0.21 dB/km (typically)	19 ps/(nm×km)
M-SFP-LH+/LC EEC	LH	1550 nm	9/125 μm	13 dB ... 32 dB	38.52 mi ... 72.07 mi (62 km ... 116 km)	0.25 dB/km	19 ps/(nm×km)
M-SFP-LH+/LC EEC	LH	1550 nm	9/125 μm	13 dB ... 32 dB	38.52 mi ... 85.75 mi (62 km ... 138 km)	0.21 dB/km (typically)	19 ps/(nm×km)

Table 16: F/O port 1000BASE-FX (SFP fiber optic Gigabit Ethernet Transceiver)

Product code	Mode ^a	Wave length	Fiber	System attenuation	Example for F/O line length ^b	Fiber attenuation	BLP/Dispersion
SFP-GIG-LX/LC...	MM	1310 nm ^f	50/125 μm	0 dB ... 10.5 dB	0 mi ... 0.34 mi (0 km ... 0.55 km)	1.0 dB/km	800 MHz×km
SFP-GIG-LX/LC...	MM	1310 nm ^g	62.5/125 μm	0 dB ... 10.5 dB	0 mi ... 0.34 mi (0 km ... 0.55 km)	1.0 dB/km	500 MHz×km
SFP-GIG-LX/LC...	SM	1310 nm	9/125 μm	0 dB ... 10.5 dB	0 mi ... 12.43 mi (0 km ... 20 km) ^h	0.4 dB/km	3.5 ps/(nm×km)

Table 16: F/O port 1000BASE-FX (SFP fiber optic Gigabit Ethernet Transceiver)

- a. MM = Multimode, SM = Singlemode, LH = Singlemode Longhaul
- b. Including 3 dB system reserve when compliance with the fiber data is observed.
- c. With F/O adapter compliant with IEEE 802.3-2002 Clause 38 (single-mode fiber offset-launch mode conditioning patch cord).
- d. With F/O adapter compliant with IEEE 802.3-2002 Clause 38 (single-mode fiber offset-launch mode conditioning patch cord).
- e. Including 2.5 dB system reserve when compliance with the fiber data is observed.
- f. With F/O adapter compliant with IEEE 802.3-2002 Clause 38 (single-mode fiber offset-launch mode conditioning patch cord).
- g. With F/O adapter compliant with IEEE 802.3-2002 Clause 38 (single-mode fiber offset-launch mode conditioning patch cord).
- h. Including 2.5 dB system reserve when compliance with the fiber data is observed.

6.5.5 Bidirectional Gigabit Ethernet SFP transceiver

Product code	Mode ^a	Wave length TX	Wave length RX	Fiber	System attenuation	Example for F/O line length ^b	Fiber attenuation	BLP/Dispersion
M-SFP-BIDI Type A LX/LC EEC	SM	1310 nm	1550 nm	9/125 μm	0 dB ... 11 dB	0 km ... 12.43 mi (0 km ... 20 km)	0.4 dB/km	3.5 ps/(nm×km)
M-SFP-BIDI Type B LX/LC EEC	SM	1550 nm	1310 nm	9/125 μm	0 dB ... 11 dB	0 km ... 12.43 mi (0 km ... 20 km)	0.25 dB/km	19 ps/(nm×km)
M-SFP-BIDI Type A LH/LC EEC	LH	1490 nm	1590 nm	9/125 μm	5 dB ... 24 dB	14.29 mi ... 49.71 mi (23 km ... 80 km)	0.25 dB/km	19 ps/(nm×km)
M-SFP-BIDI Type B LH/LC EEC	LH	1590 nm	1490 nm	9/125 μm	5 dB ... 24 dB	14.29 mi ... 49.71 mi (23 km ... 80 km)	0.25 dB/km	19 ps/(nm×km)
SFP-GIG-BA LX/LC EEC	SM	1310 nm	1550 nm	9/125 μm	0 dB ... 15 dB	0 km ... 12.43 mi (0 km ... 20 km)	0.4 dB/km	3.5 ps/(nm×km)

Table 17: F/O port (bidirectional Gigabit Ethernet SFP transceiver)

Product code	Mode ^a	Wave length TX	Wave length RX	Fiber	System attenuation	Example for F/O line length ^b	Fiber attenuation	BLP/Dispersion
SFP-GIG-BB LX/LC EEC	SM	1550 nm	1310 nm	9/125 µm	0 dB ... 15 dB	0 km ... 12.43 mi (0 km ... 20 km)	0.25 dB/km	19 ps/(nm×km)
SFP-GIG-BA LX+/LC EEC	SM	1310 nm	1550 nm	9/125 µm	3 dB ... 20 dB	7.45 mi ... 24.86 mi (12 km ... 40 km)	0.4 dB/km	3.5 ps/(nm×km)
SFP-GIG-BB LX+/LC EEC	SM	1550 nm	1310 nm	9/125 µm	3 dB ... 20 dB	7.45 mi ... 24.86 mi (12 km ... 40 km)	0.25 dB/km	19 ps/(nm×km)
SFP-GIG-BA LH/LC EEC	LH	1490 nm	1550 nm	9/125 µm	4 dB ... 24 dB	11.80 mi ... 49.71 mi (19 km ... 80 km)	0.25 dB/km	19 ps/(nm×km)
SFP-GIG-BB LH/LC EEC	LH	1550 nm	1490 nm	9/125 µm	4 dB ... 24 dB	11.80 mi ... 49.71 mi (19 km ... 80 km)	0.25 dB/km	19 ps/(nm×km)

Table 17: F/O port (bidirectional Gigabit Ethernet SFP transceiver)

- a. MM = Multimode, SM = Singlemode, LH = Singlemode Longhaul
b. Including 3 dB system reserve when compliance with the fiber data is observed.

6.6 Power consumption/power output

Name	Maximum power consumption	Maximum power output
MACH4002-48+4G	66.0 W	225.3 Btu (IT)/h
MACH4002-24G	66.0 W	225.3 Btu (IT)/h
MACH4002-24G+3X	74.0 W	252.6 Btu (IT)/h
MACH4002-48G	118.0 W	402.7 Btu (IT)/h
MACH4002-48G+3X	125.0 W	426.6 Btu (IT)/h
M4-POWER	0.0 W	0.0 Btu (IT)/h
M4-S-AC/DC 300W (230 V)	350.0 W	170.7 Btu (IT)/h
M4-S-AC/DC 300W (110 V)	370.0 W	238.9 Btu (IT)/h
M4-P-AC/DC 300W (230 V)	350.0 W	170.7 Btu (IT)/h
M4-P-AC/DC 300W (110 V)	370.0 W	238.9 Btu (IT)/h
M-SFP-LH+/LC	1.0 W	3.4 Btu (IT)/h
M-SFP-LH/LC	1.0 W	3.4 Btu (IT)/h
M-SFP-LX/LC	1.0 W	3.4 Btu (IT)/h
M-SFP-LX+/LC	1.0 W	3.4 Btu (IT)/h
M-SFP-MX/LC	1.0 W	3.4 Btu (IT)/h
M-SFP-SX/LC	1.0 W	3.4 Btu (IT)/h
M-FAST SFP-MM/LC	1.0 W	3.4 Btu (IT)/h
M-FAST SFP-SM/LC	1.0 W	3.4 Btu (IT)/h
M-FAST SFP-SM+/LC	1.0 W	3.4 Btu (IT)/h
M-FAST SFP-LH/LC	1.0 W	3.4 Btu (IT)/h
M-XFP-SR/LC	3.0 W	10.2 Btu (IT)/h
M-XFP-LR/LC	3.0 W	10.2 Btu (IT)/h
M-XFP-ER/LC	3.0 W	10.2 Btu (IT)/h
M-XFP-ZR/LC	3.0 W	10.2 Btu (IT)/h
M-SFP-BIDI Type A LX/LC EEC	1.0 W	3.4 Btu (IT)/h
M-SFP-BIDI Type B LX/LC EEC	1.0 W	3.4 Btu (IT)/h
M-SFP-BIDI Type A LH/LC EEC	1.0 W	3.4 Btu (IT)/h
M-SFP-BIDI Type B LH/LC EEC	1.0 W	3.4 Btu (IT)/h
M4-8TP-RJ45	2.0 W	7.0 Btu (IT)/h
M4-FAST-SFP	15.0 W	52.0 Btu (IT)/h
M4-GIGA-SFP	3.0 W	10.2 Btu (IT)/h

6.7 Scope of delivery

6.7.1 MACH4002-...

Amount	Article
1 ×	Device
1 ×	Safety and general information sheet
1 ×	4-pin terminal block for the signal contact
1 ×	Terminal cable
2 ×	Brackets with fastening screws (pre-mounted)

6.7.2 M4-POWER

Amount	Article
1 ×	Power supply basic device M4-POWER
1 ×	Safety and general information sheet
2 ×	Brackets with fastening screws (pre-mounted)

6.7.3 M4-S-...

Amount	Article
1 ×	Power supply plug-in unit for switch basic device M4-S-...300W
1 ×	Safety and general information sheet
Depending on device variant	Cable for AC connection for AC supply

6.7.4 M4-P-...

Amount	Article
1 ×	Power supply plug-in unit for switch basic device M4-S-...300W
1 ×	Safety and general information sheet
Depending on device variant	Cable for AC connection for AC supply
Depending on device variant	Power supply cable power supply basic device to switch basic device

6.8 Order numbers/product description

Product description	Description	Order No.
Basic devices		
	Switch chassis 48+4G (up to 48 Fast Ethernet and 4 Gigabit Ethernet ports) incl. plug-in fan unit without power supply unit	
MACH4002-48+4G-L2P	- with Layer2 Professional software	943 859-101
MACH4002-48+4G-L3E	- with Layer3 Enhanced software	943 859-201
MACH4002-48+4G-L3P	- with Layer3 Professional software	943 859-301
	Switch basic device 24G (up to 24 × Gigabit Ethernet ports) including fan plug-in unit, without power supply unit	
MACH4002-24G-L2P		943 916-101
MACH4002-24G-L3E	- with Software Layer2 Professional	943 916-201
MACH4002-24G-L3P	- with Software Layer3 Enhanced - with Software Layer3 Professional	943 916-301
	Switch basic device 48G (up to 48 × Gigabit Ethernet ports) including fan plug-in unit, without power supply unit	
MACH4002-48G-L2P		943 911-101
MACH4002-48G-L3E	- with Software Layer2 Professional	943 911-201
MACH4002-48G-L3P	- with Software Layer3 Enhanced - with Software Layer3 Professional	943 911-301
	Switch basic device 24G+3X (up to 24 × Gigabit Ethernet ports and 3 ×10 Gigabit Ethernet ports) including fan plug-in unit, without power supply unit	
MACH4002-24G+3X-L2P	- with Software Layer2 Professional	943 915-101
MACH4002-24G+3X-L3E	- with Software Layer3 Enhanced	943 915-201
MACH4002-24G+3X-L3P	- with Software Layer3 Professional	943 915-301
	Switch basic device 48G+3X (up to 48 × Gigabit Ethernet ports and 3 ×10 Gigabit Ethernet ports) including fan plug-in unit, without power supply unit	
MACH4002-48G+3X-L2P	- with Software Layer2 Professional	943 878-101
MACH4002-48G+3X-L3E	- with Software Layer3 Enhanced	943 878-201
MACH4002-48G+3X-L3P	- with Software Layer3 Professional	943 878-301
M4-POWER	Power unit chassis (for 3 slide-in units)	943 874-001
Plug-in fan units		
M4-AIR	Plug-in fan for MACH4002 switch chassis without temperature sensor	943 869-001
Plug-in power units		
M4-S-AC/DC 300W	Plug-in AC power unit (300 W) for basic switch device	943 870-001
M4-P-AC/DC 300W	Plug-in AC power unit (300 W) for power unit chassis	943 875-001
Media modules		
M4-8TP-RJ45	Plug-in module 8 TP RJ45 (10/100, 10/100/1000)	943 863-001
M4-FAST 8-SFP	Plug-in module 8 SFP (100 HDX/FDX)	943 864-001
M4-GIGA 8-SFP	Plug-in module 8 SFP (100 FDX or 1000 FDX, depending on SFP)	943 879-001

6.9 Accessories

Note that products recommended as accessories may have different characteristics to those of the device, which may limit the application range of the overall system. For example, if you add an accessory with IP20 to a device with IP65, the degree of protection of the overall system is reduced to IP20.

Fast Ethernet SFP transceiver	Order number
M-FAST SFP-TX/RJ45	942 098-001
M-FAST SFP-TX/RJ45 EEC	942 098-002
The following operating conditions apply to twisted pair transceivers:	
<ul style="list-style-type: none"> ▶ Usable with: <ul style="list-style-type: none"> - HiOS as of software version 03.0.00 - for PRP ports on RSP devices, as of software version 02.0.01 - for PRP ports on EES devices, as of software version 02.0.02 - Classic switch software as of software version 08.0.00 - HiSecOS as of software version 01.2.00 ▶ Longer RSTP switching times and link loss detection times compared to twisted pair ports provided by the device directly. ▶ Not applicable for combo ports. ▶ Not applicable for ports which support only Gigabit Ethernet. ▶ It is currently not possible to set autocrossing manually. 	
M-FAST SFP-MM/LC	943 865-001
M-FAST SFP-MM/LC EEC	943 945-001
M-FAST SFP-SM/LC	943 866-001
M-FAST SFP-SM/LC EEC	943 946-001
M-FAST SFP-SM+/LC	943 867-001
M-FAST SFP-SM+/LC EEC	943 947-001
M-FAST SFP-LH/LC	943 868-001
M-FAST SFP-LH/LC EEC	943 948-001
SFP-FAST-MM/LC ^a	942 194-001
SFP-FAST-MM/LC EEC ^a	942 194-002
SFP-FAST-SM/LC ^a	942 195-001
SFP-FAST-SM/LC EEC ^a	942 195-002

Table 18: Accessory: Fast Ethernet SFP transceiver

- a. You will find further information on certifications on the Internet on the Hirschmann product pages (www.hirschmann.com).

Bidirectional Fast Ethernet SFP transceivers ^a	Order number
SFP-FAST-BA MM/LC EEC	942 204-001
SFP-FAST-BB MM/LC EEC	942 204-002
SFP-FAST-BA SM/LC EEC	942 205-001
SFP-FAST-BB SM/LC EEC	942 205-002
SFP-FAST-BA SM+/LC EEC	942 206-001
SFP-FAST-BB SM+/LC EEC	942 206-002

Table 19: Accessory: Bidirectional Fast Ethernet SFP transceiver

- a. You find further information on certifications on the Internet on the Hirschmann product pages (www.hirschmann.com).

Gigabit Ethernet SFP transceiver	Order number
M-SFP-TX/RJ45	943 977-001
M-SFP-SX/LC	943 014-001
M-SFP-SX/LC EEC	943 896-001
M-SFP-MX/LC EEC	942 108-001
M-SFP-LX/LC	943 015-001
M-SFP-LX/LC EEC	943 897-001
M-SFP-LX+/LC	942 023-001
M-SFP-LX+/ LC EEC	942 024-001
M-SFP-LH/LC	943 042-001
M-SFP-LH/LC EEC	943 898-001
M-SFP-LH+/LC	943 049-001
M-SFP-LH+/LC EEC	942 119-001
SFP-GIG-LX/LC ^a	942 196-001
SFP-GIG-LX/LC EEC ^a	942 196-002

a. You will find further information on certifications on the Internet on the Hirschmann product pages (www.hirschmann.com).

Bidirectional Gigabit Ethernet SFP transceiver	Order number
M-SFP-BIDI Type A LX/LC EEC	943 974-001
M-SFP-BIDI Type B LX/LC EEC	943 974-002
M-SFP-BIDI Type A LH/LC EEC	943 975-001
M-SFP-BIDI Type B LH/LC EEC	943 975-002
M-SFP-BIDI Bundle LX/LC EEC (Type A + B)	943 974-101
M-SFP-BIDI Bundle LH/LC EEC (Type A + B)	943 975-101
SFP-GIG-BA LX/LC EEC ^a	942 207-001
SFP-GIG-BB LX/LC EEC ^a	942 207-002
SFP-GIG-BA LX+/LC EEC ^a	942 208-001
SFP-GIG-BB LX+/LC EEC ^a	942 208-002
SFP-GIG-BA LH/LC EEC ^a	942 209-001
SFP-GIG-BB LH/LC EEC ^a	942 209-002

a. You will find further information on certifications on the Internet on the Hirschmann product pages (www.hirschmann.com).

Name	Operating temperature (chassis)	Order number
Fast Ethernet SFP transceiver		
M-FAST SFP-MM/LC	0 °C ... +60 °C	943 865-001
M-FAST SFP-SM/LC	0 °C ...+60 °C	943 866-001
M-FAST SFP-SM+/LC	0 °C ... +60 °C	943 867-001
M-FAST SFP-LH/LC	0 °C ... +60 °C	943 868-001
Gigabit Ethernet SFP transceiver		
M - SFP - SX / LC	0 °C ... +60 °C	943 014-001
M - SFP - MX / LC	0 °C ... +60 °C	942 035-001
M - SFP - LX / LC	0 °C ... +60 °C	943 015-001
M - SFP - LX+ / LC	0 °C ... +60 °C	942 023-001
M - SFP - LH / LC	0 °C ... +60 °C	943 042-001

Name	Operating temperature (chassis)	Order number
M - SFP - LH / LC EEC	-40 °C ... +70 °C	943 898-001
Bidirectional Gigabit Ethernet SFP transceiver		
M-SFP-BIDI Type A LX/LC EEC	0 °C ... +60 °C	943 974-001
M-SFP-BIDI Type B LX/LC EEC	0 °C ... +60 °C	943 974-002
M-SFP-BIDI Type A LH/LC EEC	0 °C ... +60 °C	943 975-001
M-SFP-BIDI Type B LH/LC EEC	0 °C ... +60 °C	943 975-002
M-SFP-BIDI Bundle LX/LC EEC (Type A + B)	0 °C ... +60 °C	943 974-101
M-SFP-BIDI Bundle LH/LC EEC (Type A + B)	0 °C ... +60 °C	943 975-101
10-Gigabit Ethernet XFP transceiver		
M - XFP - SR / LC	0 °C ... +60 °C	943 917-001
M - XFP - LR / LC	0 °C ... +60 °C	943 919-001
M - XFP - ER / LC	0 °C ... +60 °C	943 920-001
M - XFP - ZR / LC	0 °C ... +60 °C	943 921-001

Other accessories	Order number
AutoConfiguration Adapter ACA22-USB (EEC)	942 124-001
Terminal cable	943 301-001
M4-POWER CABLE (connection cable for redundant power supply)	943 922-001
M4-RACKMOUNT (mounting bracket for mounting the MACH4002 in the 19" cabinet)	943 951-101
M4-RACKMOUNT (mounting bracket for mounting the MACH4002 in the 19" cabinet, 50 mm (1.97 in) lower than with M4-RACKMOUNT)	943 951-001
4-pin terminal block (50 pieces)	943 845-004
Network management software Industrial HiVision	943 156-xxx

6.10 Underlying technical standards

Standard	
EN 61000-6-2	Electromagnetic compatibility (EMC) – Part 6-2: Generic standards – Immunity for industrial environments
EN 55032	Electromagnetic compatibility of multimedia equipment – Emission Requirements
IEC/EN 62368-1	Equipment for audio/video, information and communication technology - Part 1: safety requirements
EN 61131-2	Programmable controllers – Part 2: Equipment requirements and tests
EN 50121-4	Railway applications - EMC - emitted interference and interference immunity for signal and telecommunication systems
FCC 47 CFR Part 15	Code of Federal Regulations
Germanischer Lloyd	Rules for Classification and Construction VI-7-2 – GL
UL 508	Safety for Industrial Control Equipment
UL 60950-1	Information technology equipment – Safety – Part 1: General requirements

Table 20: List of the technical standards

The device has an approval based on a specific standard exclusively if the approval indicator appears on the device casing.

If your device has a shipping approval according to DNV GL, you find the approval mark printed on the device label. You will find out whether your device has other shipping approvals on the Hirschmann website at www.hirschmann.com in the product information.

A Further support

Technical questions

For technical questions, please contact any Hirschmann dealer in your area or Hirschmann directly.

You find the addresses of our partners on the Internet at <http://www.hirschmann.com>.

A list of local telephone numbers and email addresses for technical support directly from Hirschmann is available at <https://hirschmann-support.belden.com>.

This site also includes a free of charge knowledge base and a software download section.

Customer Innovation Center

The Customer Innovation Center is ahead of its competitors on three counts with its complete range of innovative services:

- ▶ Consulting incorporates comprehensive technical advice, from system evaluation through network planning to project planning.
- ▶ Training offers you an introduction to the basics, product briefing and user training with certification.
You find the training courses on technology and products currently available at <https://www.belden.com/solutions/customer-innovation-center>.
- ▶ Support ranges from the first installation through the standby service to maintenance concepts.

With the Customer Innovation Center, you decide against making any compromises in any case. Our client-customized package leaves you free to choose the service components you want to use.

Internet:

<https://www.belden.com/solutions/customer-innovation-center>



HIRSCHMANN

A **BELDEN** BRAND